

EXPERIENTIAL LEARNING 2022-2023

EXPERIENTIAL LEARNING 2022-2023
DEPARTMENT OF ENGLISH

REPORT OF STUDY TOUR (2022-2023)

Title of the activity: STUDY TOUR

Speaker: NA

Objective of the activity:

- To make the students aware of the Danish Colonial settlement at Serampore
- To raise the interest of the students in understanding colonial history and ancient history of India
- To make learning delightful

Type of the activity: Study Tour

Organizing Department: Department of English

Place of activity: **The Governor's House, Serampore & Museum**

Date and time of the activity: **12 APRIL 2023** (From 1 pm-4pm) Number of attendees: (a) students: 57 (b) teachers: 06

Outcome:

- The study tour to the Governor's House enriched our students immensely in an interdisciplinary way and the teachers benefitted no less than them.
- The students were enriched by the introductory lecture of Mr Mohit Ranadip, a member of Serampore Heritage Restoration Initiative(SHRI)
- The tour was enjoyable for all. Sharing and learning have a different flavour of its own.
- The students were acquainted with the rich educational and cultural heritage of Serampore

NOTICE FOR STUDENTS

NOTICE FOR STUDENTS

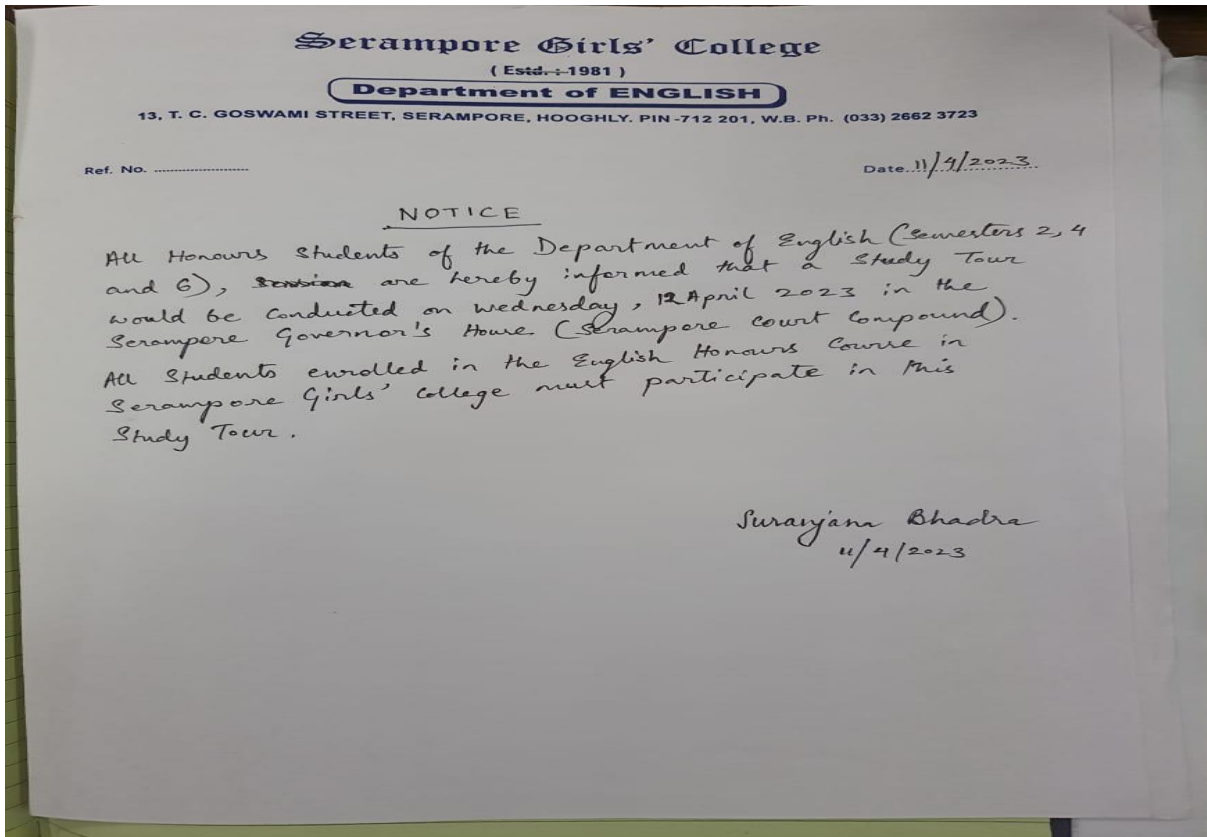

Letter for permission for Study Tour

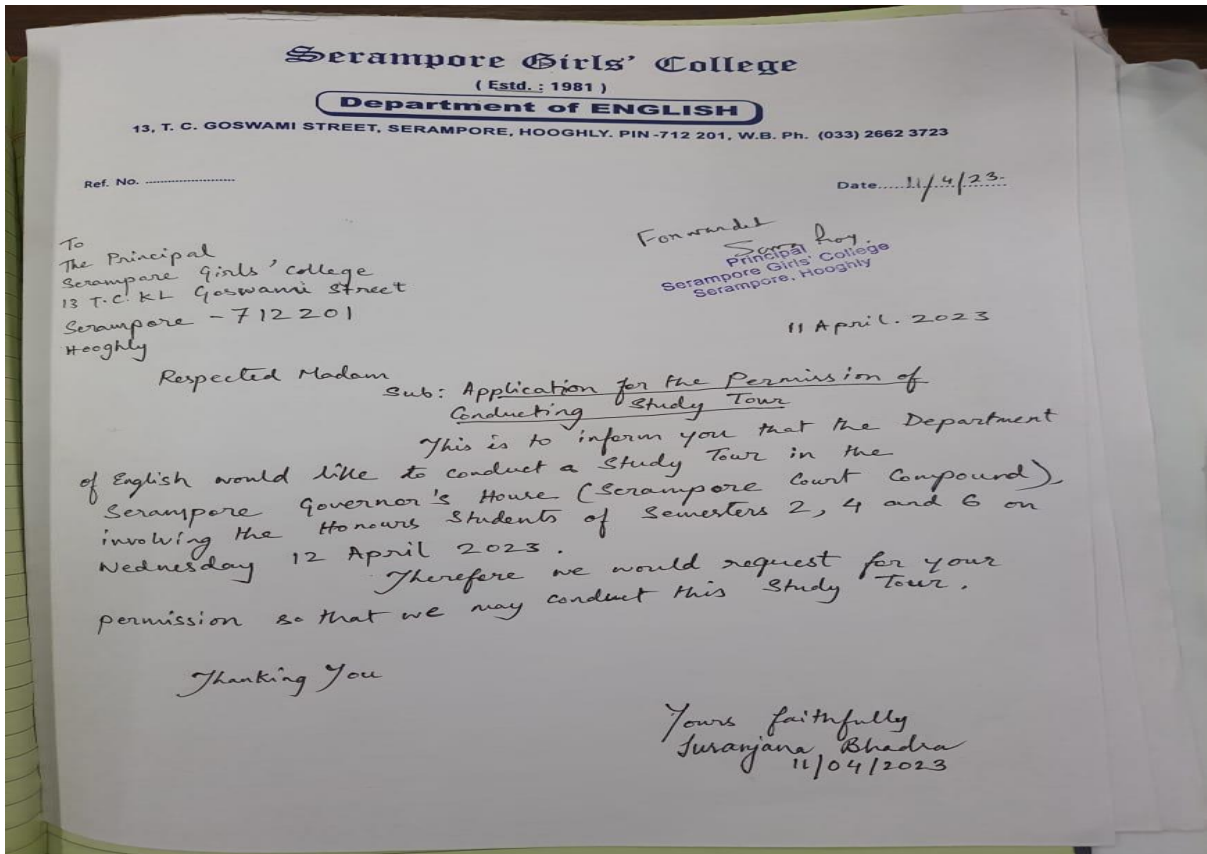



ATTENDANCE SHEET

SERAMPORE GIRLS' COLLEGE
DEPARTMENT OF ENGLISH
SEMINAR/ EXTENSION LECTURE/ OPEN HOUSE/
QUIZ /EDUCATIONAL TOUR/ OTHERS

TIME: 2:00 P.M DATE: 12/04/2023

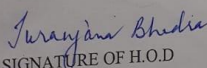
S.N	NAME OF THE PARTICIPANTS	COLLEGE ROLL NO.	SEMESTER
1	Madahiya Ansh	21147	4
2	Puja Ghosh	21126	4
3	Amrita Kumari	21103	4
4	Anushka Das	21102	4
5	Tandra Das	21141	4
6	Tania Afruja	21142	4
7	Megha Chakrabarty	21120	4
8	Mahin Mahid Safina	21115	4
9	Anchana Bhattacharjee	21109	4
10	Pohano Chatterjee	21125	4
11	Kiron Shaha	21116	4
12	Trishita Ghosh	21113	4
13	Pooja Chakrabarty	21129	4th
14	Mahamata Mallik	21119	4th
15	Amrita Patra	21104	4th
16	Smita Biswas	21139	AM Sem
17	Ishrat Barveen	21114	4
18	Jayanti Chatterjee	21158	4
19	Sagarika Bhattacharjee	21129	4th



 SIGNATURE OF H.O.D



 SIGNATURE OF PRINCIPAL

SERAMPORE GIRLS' COLLEGE
DEPARTMENT OF ENGLISH
SEMINAR/ EXTENSION LECTURE/ OPEN HOUSE/
QUIZ /EDUCATIONAL TOUR/ OTHERS

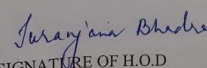
TIME: 2 PM DATE: 12/04/23

S.N	NAME OF THE PARTICIPANTS	COLLEGE ROLL NO.	SEMESTER
1	Ritika Dey	22102	2
2	Sneha Sarkar	22144	Sem - II
3	Moumita Bhui	22125	2nd
4	Janakshani Ghosh	22113	2nd
5	Samshana Kumari	22151	2 (Sem-II)
6	Shreela Sharmis	22120	2
7	Rama Bandui	22134	2nd Semester
8	Aranya Roy	22141	2
9	Janya Ghosh	22150	2nd sem
10	Sneha Datta	22143	2
11	Shradha Karmakar	22149	2nd
12	Amrita Das	22120	2nd
13	Sulagna Chatterjee	22803	2nd sem.
14	Roshni Ghosh Jadav	22131	2
15	Mousumi Patra	22136	2
16	Tina Malik	22152	2 (II)
17	Suparna Ban	22148	II
18	Jaganmala Jaiswal	22132	II Sem
19	Dona Karmakar	22117	II (Sem 2)

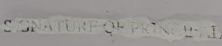
 SIGNATURE OF H.O.D

 SIGNATURE OF PRINCIPAL

ATTENDANCE SHEET

SERAMPORE GIRLS' COLLEGE
DEPARTMENT OF ENGLISH
SEMINAR/ EXTENSION LECTURE/ OPEN HOUSE/
QUIZ / EDUCATIONAL TOUR/ OTHERS

TIME: 2:00 P.M. **DATE:** 12/4/2023

S.N	NAME OF THE PARTICIPANTS	COLLEGE ROLL NO.	SEMESTER
1	Suwa Biswas	21139	4 th
2	Shreyasee Pramanik	21132	4 th
3	Jaya Dey	20118	6 th
4	Bata Pramanik	20113	6 th
5	Beneeta Karar	20114	6 th
6	Aishee Bandyopadhyay	20108	6 th
7	Pratibha Chakraborty	20132	6 th
8	Smyantika Das	20143	6 th
9	Sheshashree Samanta	20144	6 th
10	Piyali Pal	20129	6 th
11	Surraja Ahatin	20142	6 th
12	Sayoni Chakraborty	19172	6 th
13	FALGUNI GAYEN	20133	6 th
14	Madhumita Mandal	20148	6 th
15	Krutika Mukherjee	20120	6 th
16	Sneha Lal	20148	6 th
17	Sudhepta Bose	20151	6 th
18	Durga Banerjee	20700	6 th
19	Shraddha Bhattacharya	20150	6 th

Surajana Bhadra
SIGNATURE OF H.O.D

Students and Teachers visiting The Governor's House, Serampore



The students exploring the Museum

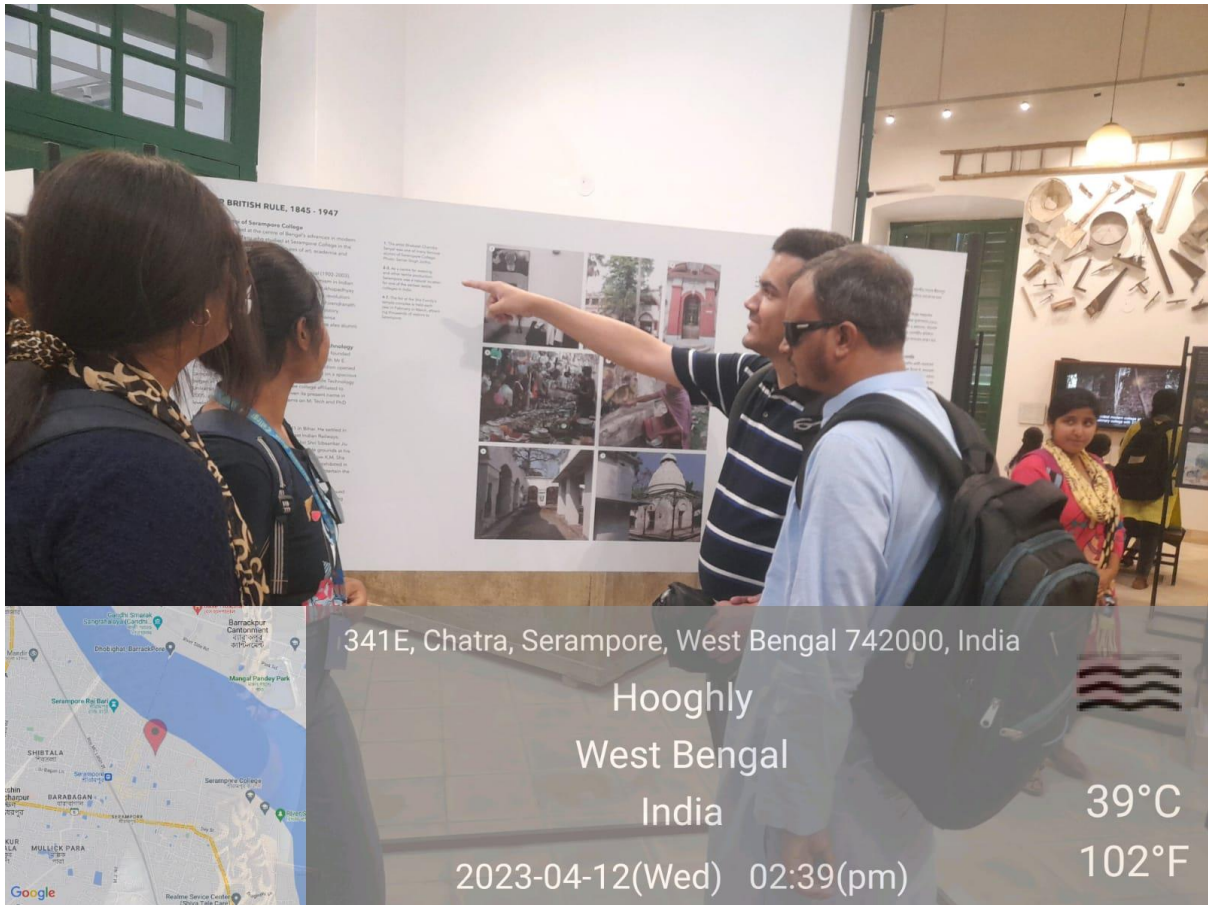

students exploring the musuem

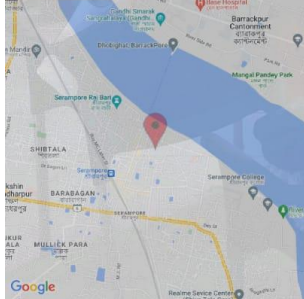

Q84V+93M, Serampore, West Bengal 712201, India

Hooghly

West Bengal

India

2023-04-12(Wed) 03:03(pm)

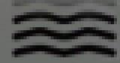

39°C

102°F

Mr.Mohit Ranadeep Addressing the students in the Governer's House

DEPARTMENT OF BENGALI

Report of study tour of department of Bengali

Report format of Students centric method of teaching learning

Organising Department: BENGALI Academic Session:2022-2023

Report onSTUDY TOUR.....EVENT

Type of the Activity: (e.g experiential)

Objective of the Event: Practical knowledge of folk leature and folk songs

Date: 12.04.2023

Time of the Event: 10:00- 5:00

Number of attendees: (a) Student (mention semester): 18

(b) Teacher: 04

Venue: shantiniketansrijani Shilpa gram, *Bolpur* .

Outcome: 1)student learned what is folk culture and folk song

2) how to collect and preserve any folk dokuments

3) practical noledge abut any folk culture

Attach notices, photos, attendance sheet,

Signature of HOD

**Head of the Department
Department of Bengali**

Ph. : (033) 26623723 (Office)
(033) 26527850 (Principal)

Serampore Girls' College

(Estd.: 1981)

Re-Accredited by NAAC : Grade B (2nd Cycle)

13, T. C. GOSWAMI STREET, SERAMPORE, HOOGHLY. PIN-712 201, WEST BENGAL.

E-mail : serampore_girls_college@yahoo.co.in
Website : www.seramporegirlscollege.org

Ref. No.

Date 01.04.2023

NOTICE

This is to notified that an Educational tour arranged by Bengali Department to visit the Santiniketan, Bolpur Srijani Silpa Gram on 12.04.2023.

Please contact with HOD .

Head of the Department
Department of Bengali
Serampore Girls' College

ATTENDANCE DURING FIELD VISIT

Serampore Girls' College

13, T.C. Goswami Street, Serampore, Hooghly - 712201, West Bengal, India

DEPARTMENT: BENGALI

STUDY TOUR

20...22... - 20...23 Date - 12-04, 2023.

1.	Riya Santra (20034)	13.	Sonu Koley
2.	Diparmita Deb (20048)	14.	Arshana Majumdar
3.	Nikita Purkait (20020)	15.	Suraddha Dutta
4.	Soumi Adak (20046)	16.	Ishita Nandy,
5.	Sukirti Kundu (20049)	17.	Mammi Santra.
6.	Hritika Malakar (20012)	18.	Fatema Khatun
7.	Arpita Mondal (20045)		
8.	Toishna Das (20056)		
9.	Arpita Mondal (20007)		
10.	Tiyasha Dholey. (20054)		
11.	Papia Santra (20021)		
12.	Rama Das. (20031)		

PHOTOS OF STUDY TOUR



PHOTOS OF STUDY TOUR

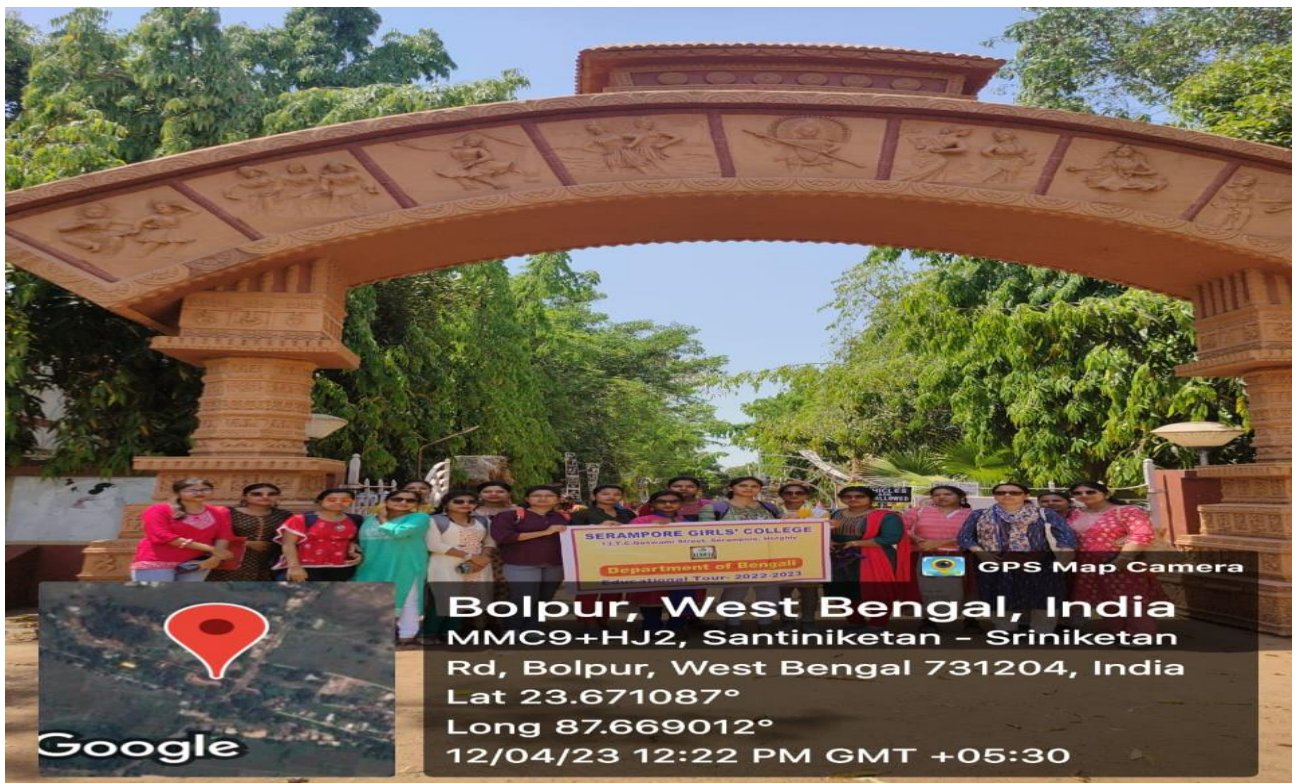

DEPARTMENT OF SANSKRIT

REPORT OF PROJECT

SEMESTER-6

ORGANISING DEPARTMENT: SANSKRIT

ACADEMIC SESSION:2022-23

REPORT ON- Experiential learning

SEMESTER - VI (SIX)

NAME OF COURSE – Sanskrit composition and communication

COURSE OBJECTIVE - Students will learn

- 1.entertainment
- 2.natianaland international affairs
- 3.social problems

Date - 28.04.23 - 29.04.23

TIME- 11.00-2.00 PM

Students participated – 20

Name of Teachers :

1. Kabery Hossain(Teacher and HOD,Dept of Sanskrit, Serampore Girls' College)
2. Silpi Adhikari(Teacher,Dept of Sanskrit, Serampore Girls' College)

Course Outcome –

1. In this way students learned about the social problems and the method of solution.
- 2.To writing to various aspects of Sanskrit language.

Kabery Hossain
Head of the Department
Department of Sanskrit

Soma Roy.
Principal
Serampore Girls' College
Serampore, Hooghly

PROJECT
SEMESTER-6
SESSION-2022-23
NOTICE

Ph. : (033) 26623723 (Office)

Serampore Girls' College

(Estd.: 1981)

Re-Accredited by NAAC : Grade B (2nd Cycle)

13, T. C. GOSWAMI STREET, SERAMPORE, HOOGHLY. PIN-712 201, WEST BENGAL.

E-mail : serampore_girls_college@yahoo.co.in

Website : www.seramporegirlscollege.org

Date 13/4/23

No.

It is decided that the project of 6th sem honours students will be submitted in the last week of April on syllabus based topic and Paper- cc-14. Viva date is given below.

Cc-14 - Tutorial - Last week of April

Cc-14 - Internal - 2nd week of May - This will be held on online mode by viva system according to universities scales.

Silpi Adhinari

Dept. of Sanskrit

PROJECT
SEMESTER-6
SESSION-2022-23
STUDENTS ATTENDANCE SHEET

Semester-6: Project submission

BLANK AWARD LIST

EXAMINATION: Tutorial - 6th Sem

SUBJECT: SANA

SUB CATEGORY: CC-14

ASSESSMENT TYPE: Project

SL NO.	ROLL NO.	Signature REGISTRATION NO.	MARKS OBTAINED IFM: / /
1.	202614-11-0001	Riya Pal	29.04.2023
2.	-0005	Payel Pal.	29.04.2023
3.	-0007	Riya Nandi.	29.04.2023
4.	-0027	Tuheli Bar	29.04.23
5.	-0053	Priyanka Dutta	29.4.23
6.	-0094	Mayabati Kundu	28.4.23
7.	-0096	Ralita Bhara	28.04.23
8.	-0117	Debasmita Dutta	29.04.23
9.	-0132	Sayani Dey	29.04.23
10.	-0133	Pallika Dey.	29.04.23
11.	-0146	Aaroin Khatun	28.4.2023
12.	-0166	Tanvira Bhattacharya	6.5.23
13.	-0193	Neha Mal	29.4.23
14.	-0208	Tijasa Santra	29.4.23
15.	-0216	PUJA Dolui	28.4.2023
16.	-0223	Rituparna Sardar.	29.4.23
17.	-0228	Jyotirmoyee Sardar	28.04.23
18.	-0232	Panchumi Bistua	6.5.23
19.	-0238	Puja Bar	29.04.23
20.	-0277	Aishwarya Das	29.04.23

Signature of Internal Examiner

Signature of Principal with date & seal

EXAMPLE OF STUDENTS PROJECT COPY

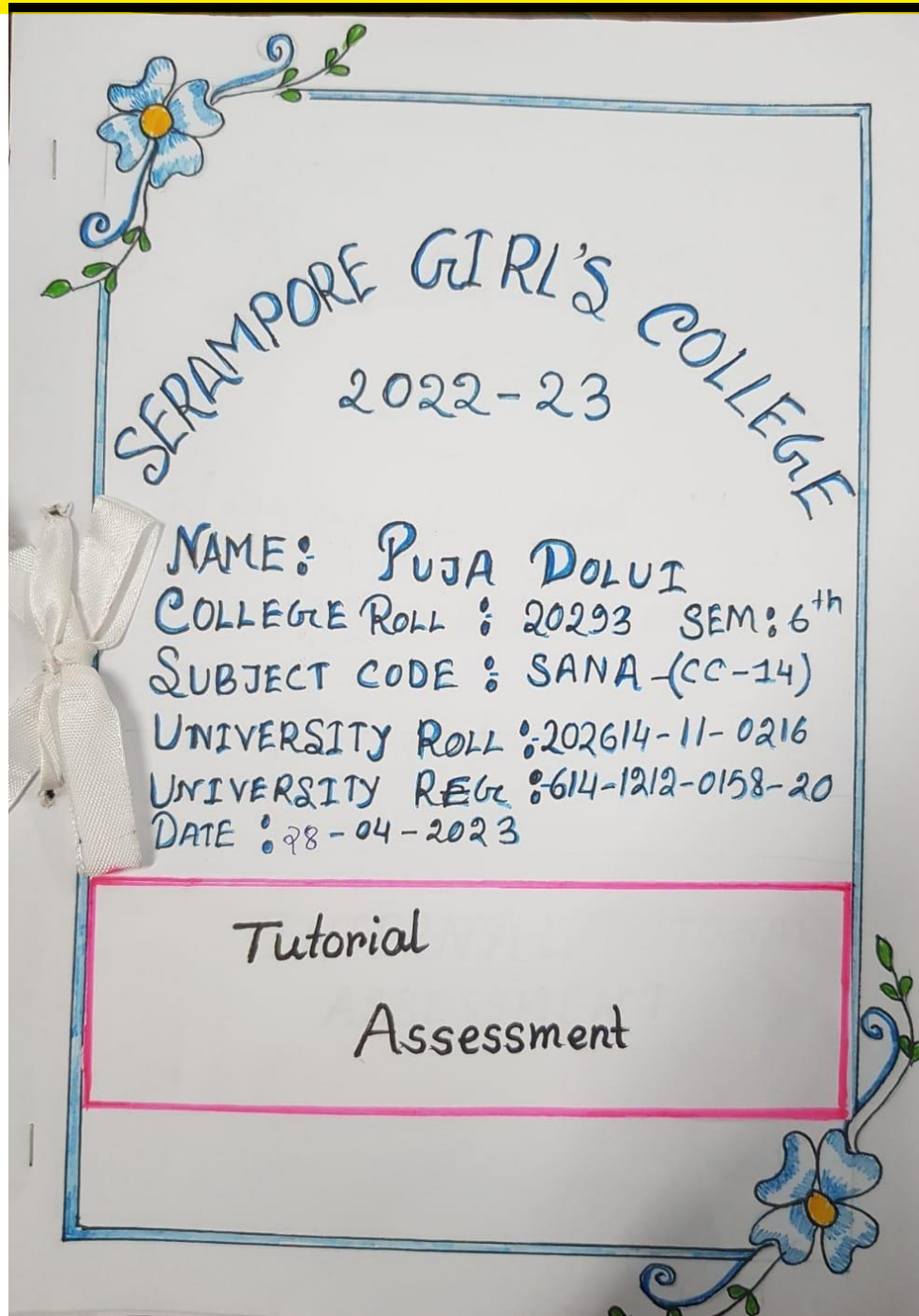

लोकतन्त्रवाद

■ लोकतन्त्रस्य स्वरूपम् : ⇒

तन्त्रं नाम शासनम्, परन्तु तन्त्रशब्दः
 अनेकेषु अर्थेषु व्यवहृत्यते, राजनीतिविषये तन्त्रशब्दस्य
 'शासनम्' इति अर्थं प्रसिद्धम्, गणशब्दः समूहवाचकः
 अस्ति 'सामूहिकविधिना शासनम्' इति लोकतन्त्रवादस्य
 भावः, लोकानां अर्थात् जनानां प्रजानां वा तन्त्रं शासनं
 लोकतन्त्रम् इत्यभिधीयते, लोकतन्त्रशब्दस्य अनेकाः परिभाषाः
 उपलभ्यन्ते, जनतन्त्रं जनतायाः शासनम्, लोकद्वारा
 सञ्चालितम्, लोकहितार्थं च भवति, अस्मिन्नेव
 शासनतन्त्रे प्रजाः शासनकार्येषु प्रत्यक्षमुत्तरदायित्वं वहन्ति,
 मतदानविषये शासनव्यवस्थां स्वीकर्तुम् अस्वीकर्तुं च अधिकार-
 तासां भवति, अस्माकं देशे इत्थमेव व्यवस्थां सर्वे राष्ट्र-
 सेवकाः प्रचारिताः।

■ आत्रादमल्लिङ्गमदीदृशेन लोकतन्त्रस्य
 परिभाषायामुक्तम् - It is a government of the
 people, by the people and for the people.

DEPARTMENT OF HISTORY

Report format of Students centric method of teaching learning

Organising Department: **HISTORY**

Academic Session: **2022-23**

Report on **One Day Field Visit and Workshop**

Type of the Activity: experiential

Objective of the Event Workshop on the occasion of World Heritage Day

Date: 28/04/2023

Time of the Event: 11.00am-2.30pm

Number of attendees: (a) Student 58 (Sem 2/4/6):

(b) Teacher: 4

Venue: Serampore Raj Bari, Serampore Hooghly

Speakers (if any) : Kaushik Chatterjee (G.B. Member of Serampore Girls' College)

Outcome: Students understood the concept of preservation and conservation of local heritage.

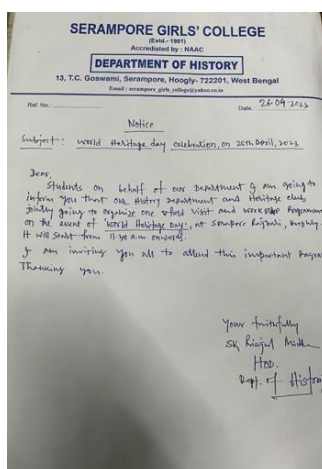

Flyer for Serampore Raj Bari



Workshop with the speaker, Mr. Kaushik Chatterjee (Lawyer of Serampore Court and GB Member of SGC)

Attendance sheet Sem II, IV, VI

Field visit and workshop
on the occasion of World Heritage Day

Place: Serampore Kalyani.
Date: 26/11/2023 Time: 11:30 am onwards to 2:30 pm

Name & Roll No.	HISA 2nd Sem Students (Attendance)	Feedback
1) Saraswati Sarda (22224)		Very good
2) Sayani Mondal (22217)		Very Nice
3) Sukanya Das (22224)		Very good
4) Subhamita Ghosh (22205)		Good
5) Nikhat Nishat (22205)		Good
6) Kim Kim Choudhary (22200)		Good
7) Anomita Mukherjee (22229)		Good
8) Debasmita Bhattacharya (22193)		Good
9) Priya Hazra (22209)		Good
10) Nayana Dasgupta (22202)		Very Good
11) Ananya Sanyal (22196)		Good

Field visit and workshop on the occasion of
World Heritage Day

Place: Serampore Kalyani.
Date: 26/11/2023 Time: 11:30 am onwards to 2:30 pm

Name & Roll No.	HISA 4th Sem Students	Feedback
1. Chandanika Chatterjee (21183)		Nice
2. Rakhi Ghosh (21168)		Good
3. Sreyasi Ghosh (21180)		Very nice
4. Palli Pal (21180)		Very nice
5. Manisa Singh (21180)		Very good
6. Sarita Tirth (21180)		Good
7. Ananya Saha (21180)		Good
8. Rya Choudhary (21124)		Good
9. Shabnam Raza (2083)		Good
10. Ananya Kumar (21180)		Good
11. Jyoti Kumar (21180)		Good
12. Shikha Kumari Das (21180)		Good
13. Kanishka Paswan (21180)		Good
14. Adurita Ghosh (21180)		Very nice
15. Roshni Mondal (21180)		Good
16. Nisha Das (21180)		Good
17. Lisa Bhat (21180)		Good
18. Ananta Mukherjee (21180)		Good
19. Anika Chakrabarty (21180)		Good
20. Anika Majumdar (21180)		Good
21. Neha Das (21180)		Good
22. Barsha Das (21180)		Good
23. Shilpa Malik (21180)		Good
24. Ritika Paul (21180)		Good
25. Anghamita Bhunia (21180)		Good
26. Mandira Roy (21180)		Good
27. Mamoni Roy (21180)		Good
28. Bidisha Ghosh (21180)		Not bad
29. Nisha Das (21180)		Not bad
30. Ananya Das (21180)		Good

Field visit and workshop
on the occasion of World Heritage Day

Place: Serampore Kalyani.
Date: 26/11/2023 Time: 11:30 am to 2:30 pm

Name & Roll No.	HISA 6th Sem Students	Feedback
1. Neha Kumari Das (20176)		Very good
2. Shaheen Farman (20190)		Very good
3. Simran Kumari Shaw (20190)		Very good
4. Ananya Kumari Shaw (20192)		Very nice
5. Anshree Ray (20182)		Good
6. Anika Khan (20180)		Good
7. Anika Khan (20180)		Good
8. Anika Khan (20180)		Good
9. Anika Khan (20180)		Good
10. Anika Khan (20180)		Good
11. Anika Khan (20180)		Good
12. Anika Khan (20180)		v.v. good
13. Anika Khan (20180)		Very useful
14. Anika Khan (20180)		Very nice
15. Anika Khan (20180)		Very good
16. Anika Khan (20180)		Very good
17. Anika Khan (20180)		Very good

Teacher's Signature
M. Das
26/11/23

<https://youtu.be/S9jo2WO1BSM>



Publication on e paper- "ei-somoy"

Youtube link

Report on Know Your Local Heritage EVENT Project work

Type of the Activity: experiential

Objective of the Event. Understanding the architectural style

Date: 20/9/2022-31/01/23 Time of the Event:

Number of attendees: (a) Student 16 (semester I/III/V)

(b) Teacher: 1 (Sk Riajul Midde as Supervisor)

Venue: NA

Outcome: Students understood the concept of preservation and conservation of local heritage.

Notice

Project

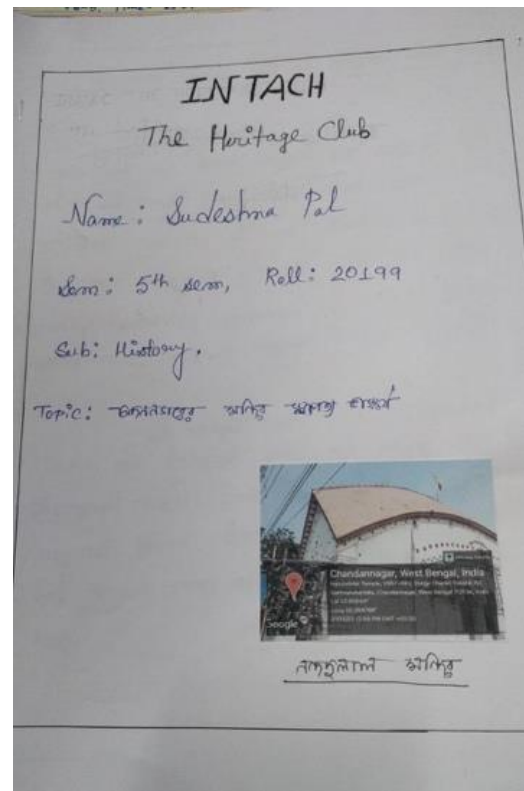
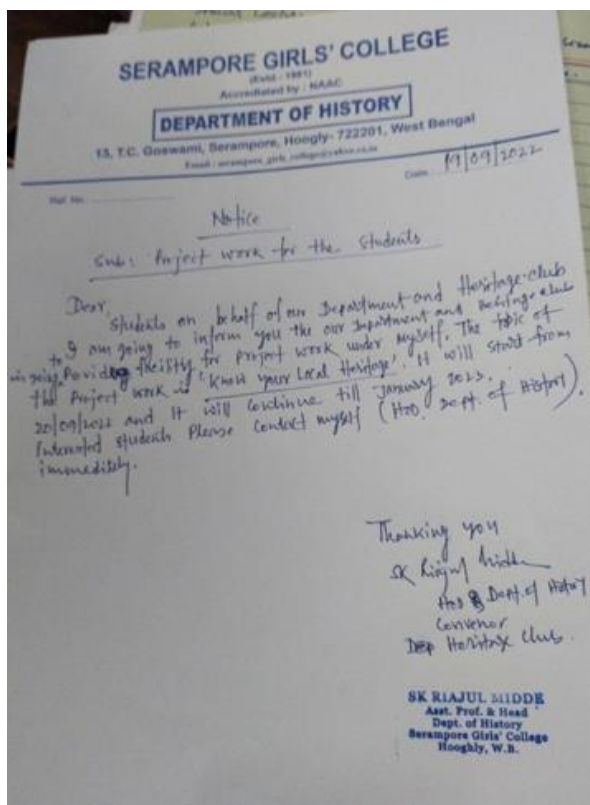

Report on World Heritage week celebration

EVENT Study Tour

Type of the Activity: experiential

Objective of the Event Preservation and conservation of local Heritage and creating awareness among the students

Date: 24/11/23

Time of the Event: 11.00-12.30pm

Number of attendees: (a) Student 82 (Sem I,III,V):

(b) Teacher: 5

Venue: Danish Governor House, Serampore Court, Hooghly

Speakers (if any) : Mohit Ranadib (Member of SHRI)

Outcome: They got the knowledge about the exhibition.

Notice

Sample Attendance Sheet (Sem I, III, V)

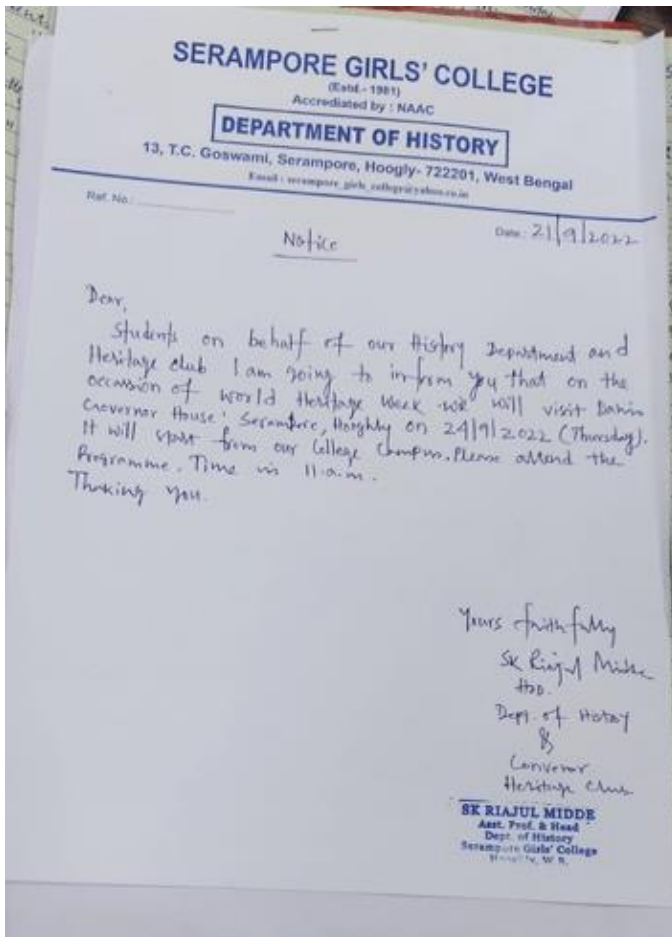

date: 24/11/2022

Name & Signature	Sem.	Roll No	Remarks
1. Richena Banerjee	HISA 1st Sem	22192	Very Good
2. Bidisha Sankar	HISA (1st Sem)	22192	Very Good
3. Debi Pasi	HISA (1st Sem)	22208	Very Good
4. Sunika Das	HISA (1st Sem)	22226	Very Good
5. Sarani Das	HISA (1st Sem)	22216	Very Good
6. Mandina Malik	HISA (1st Sem)	20202	Very Good
7. Rimi Das	HISA (1st Sem)	22210	Very Good
8. Sarani Sarker	HISA (1st Sem)	22215	Very Good
9. Shilpa Malina	HISA (1st Sem)	22219	Very Good
10. Anshika Bhattacharya	HISA (1st Sem)	22219	Very Good
11. Susmita Mukherjee	HISA (1st Sem)	22229	Very Good
12. Diba Das	HISA (1st Sem)	22194	Very Good
13. Anshika Bhattacharya	HISA (1st Sem)	22202	Very Good
14. Lakshmi Patra	HISA (1st Sem)	22201	Very Good
15. Sayani Mondal	HISA (1st Sem)	22217	Very Good
16. Anika Nandi	HISA (1st Sem)	22227	Very Good
17. Anubrata Sarker	HISA (1st Sem)	22222	Very Good
18. Anika Das	HISA (1st Sem)	22212	Very Good
19. Anika Sarker	HISA (1st Sem)	22196	Very Good
20. Anika Sarker	HISA (1st Sem)	22221	Very Good
21. Anika Das	HISA (1st Sem)	22224	Very Good
1. Anika Bhattacharya	HISA (1st Sem)	20200	Very Good
2. Anika Das	HISA (1st Sem)	20189	Very Good
3. Anika Das	HISA (1st Sem)	20186	Very Good
4. Anika Das	HISA (1st Sem)	20188	Very Good
5. Anika Das	HISA (1st Sem)	20202	Very Good
6. Anika Das	HISA (1st Sem)	20188	Very Good
7. Anika Das	HISA (1st Sem)	20161	Very Good
8. Anika Das	HISA (1st Sem)	20168	Very Good
9. Anika Das	HISA (1st Sem)	20197	Very Good
10. Anika Das	HISA (1st Sem)	20167	Very Good
11. Anika Das	HISA (1st Sem)	20185	Very Good

Soma Roy
Principal
Serampore Girls' College
Serampore, Hooghly

Images of the study tour

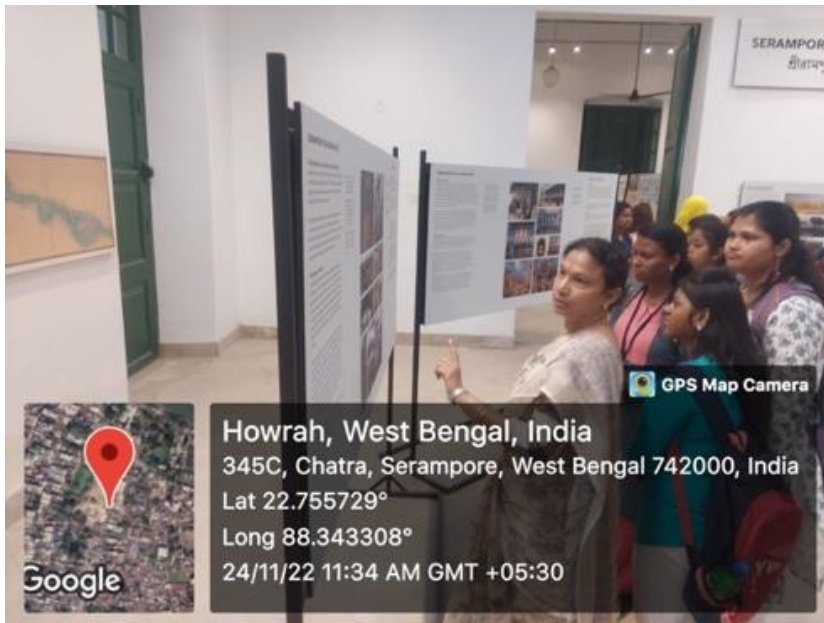
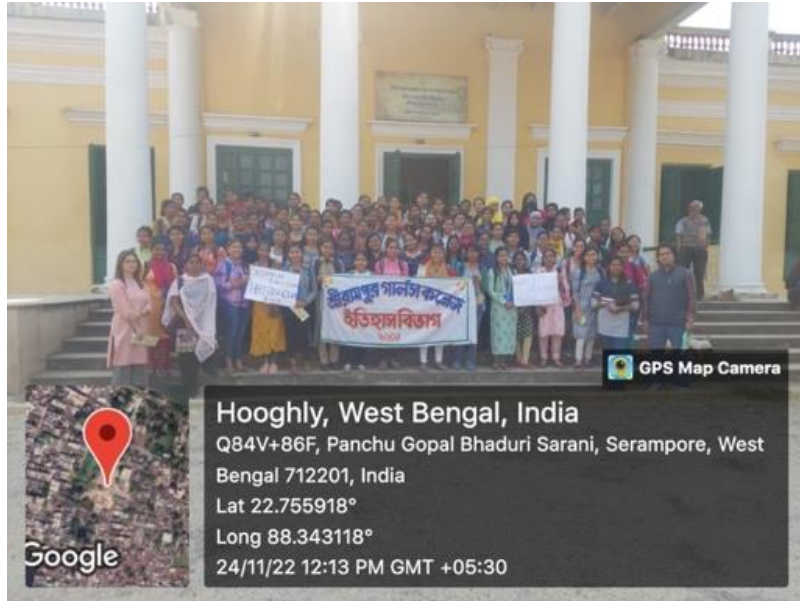

DEPARTMENT OF PHYSICAL EDUCATION

Report format of Students centric method of teaching learning

Organising Department: Academic Session: 2022-2023

Report on.....PROJECT

✓

Type of the Activity: (e.g experiential/participative/Problem solving/ICT)

Objective of the Event: To enhance their skill, self study and group study also.

Date: 03.01.2023 **Time of the Event:** 11.30AM, 12.00PM, 1.00PM

Number of attendees: sem I -38, sem III -16 , sem V- 04

Teacher: 1(Mrs. Sayanti Banerjee)

Venue: Gymnasium, Serampore Girls' College

Outcome: 1) They gather their knowledge from different dimention.

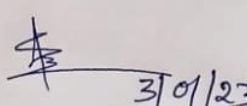
Signature of HOD

Head of the Department
Department of Physical Education

SERAMPORE GIRLS' COLLEGE
DEPARTMENT OF PHYSICAL EDUCATION

NOTICE

Date: 20.12.22

It is informed to all the Students of Semester I, II and III of Physical Education that Project will be submitted on 08.01.23 at 11.30 am, 12.00 pm and 1.00 pm respectively. The Practical Examination (Project) will be held according to CU exam routine.

20/12/22
Dept. Physical Education

UNIVERSITY OF CALCUTTA
SERAMPORE GIRLS' COLLEGE



PHYSICAL EDUCATION

UNIT : I

NAME : SUSMITA KUNDU.
STREAM : B.A. (GEN) (3rd SEM)
ROLL NO. : 20686.
SUBJECT : PHYSICAL EDUCATION.
REG. NO. : 614-1214-0618-20
C.U. ROLL NO. : 202614-12-0295

SESSION - 2022-2023

SERAMPORE GIRLS' COLLEGE
UNIVERSITY OF CALCUTTA
BA 2ND YEAR III SEMESTER (GENERAL)



TRACK AND FIELD

NAME : MADHUSHRI DUTTA.
STREAM : 2ND YEAR 3RD SEM GENERAL.
COLLEGE ROLL : 21489
REGISTRATION : 614-1211-0577-21
C.U. ROLL NO. : 212614-12-0125
SUBJECT : PHYSICAL EDUCATION (PEDG).
PROJECT NAME : TRACK AND FIELD
SESSION : 2022 - 2023

UNIVERSITY OF CALCUTTA
SERAMPORE GIRLS COLLEGE



NAME :- RANITA GARANG
SUBJECT :- "PEDG"
PAPER : CCT/GE1
COLLEGE ROLL NO :- 22599
REGISTRATION NO :- 614-1211-0353-22
SEMESTER :- 1ST
YEAR :- 2022-2023

PROJECT WORK BY STUDENTS

REPORT OF PROJECT WORK

Report format of Students centric method of teaching learning

Organising Department: Academic Session: 2022-2023

Report on..... PROJECT

✓
Type of the Activity: (e.g experiential/participative/Problem solving/ICT)

Objective of the Event: To enhance their skill, self study and group study also.

Date: 16.06.2023 **Time of the Event:** 11 .00 AM, 12.00PM, 1.00PM

Number of attendees: Sem II -38, Sem IV -16 , Sem VI- 04

Teacher: 2(Mrs. Tania Nag & Mrs. Sayanti Banerjee)

Venue: Gymnasium, Serampore Girls' College

Outcome: 1) They gather their knowledge from different dimention.

Tania Nag 16.06.23
Signature of HOD
Head of the Department
Department of Physical Education

IMAGES OF PROJECT WORK

SERAMPORE GIRLS COLLEGE
DEPARTMENT OF PHYSICAL EDUCATION

NOTICE

It is informed to all the students of Semester ^{III} II, IV and V of Physical Education that all of you submit your Project on 16.06.23 at 11 am, 12 pm and 1 pm respectively. The Project (Practical) examination will be held according to CU exam routine.

Date: 08.05.23

T.D.
Dept. Physical Education

UNIVERSITY OF CALCUTTA
SERAMPORE GIRLS COLLEGE



NAME :- RITU SHOW

SUBJECT :- PEDG

PAPER COAD :- SEC-B1

COLLEGE ROLL NO :- 21593

C.U ROLL NO :- 212614-12-0055

REGISTRATION ON :- 614-1211-0441-21

SEMESTER :- B.A (GEN) (4TH SEM)

YEAR :- 2022 - 2023

UNIVERSITY OF CALCUTTA
SERAMPORE GIRLS COLLEGE



A PROJECT ON PHYSICAL EDUCATION

SUBMITTED BY

NAME : SHREYA KUMARI

SUBJECT : PHYSICAL EDUCATION

PAPER : CC2/GE2

SEC :

TOPIC : UNIT - I - IV

CLASS : BA. SEM -II(GEN.)



ROLL NO. : 22691

UNIVERSITY ROLL : 222614-12-0366

REG NO : 614-1211-0701-22

YEAR : 2022-2023

UNIVERSITY OF CALCUTTA
SERAMPORE GIRLS COLLEGE

SERAMPORE GIRLS COLLEGE



PHYSICAL EDUCATION

NAME : TINA ADAK

CLASS : B.A. (GEN)

COLLEGE ROLL : 20687

C.U ROLL : 202614-12-0236

C.U ROLL : 614-1212-0438-20

SEMESTER : 6th SEM

YEAR : 2022-2023

DEPARTMENT OF MUSIC

Report of Students centric method of teaching learning

Organising Department: Music Academic Session:2022-23

Report on **Project Work**

Type of the Activity: **Experiential Learning**

Objective of the Event : How to develop a Project paper by maintain proper Methodology

Date: 16.11.2022

Time of the Event: 2pm

Number of attendees: (a) Student (1stand 3rd semester): 17

(b) Teacher: 02

Venue: Department of Music (Room no. NB-6):

Supervisor: Rupa Bandyopadhyay and Suchandra Maitra

Outcome: They learnt a lot by this experiential activity and know at a glance how to prepare a research paper .

Attach notices, photos, attendance sheet, speakers

NOTICE FOR THE PROJECT

SERAMPORE GIRLS' COLLEGE

Department of MUSIC

NOTICE

D-2-11-2022

All students of B.A. 1st sem and 3rd semester general are informed that submit your project work on 16.11.2022 without fail.

Date of Submission: 16.11.2022

Semester : 1st and 3rd

Rupa Bandyopadhyay

02.11.2022

Head of the Department
Department of Music

FRONT PAGE OF PROJECT REPORT

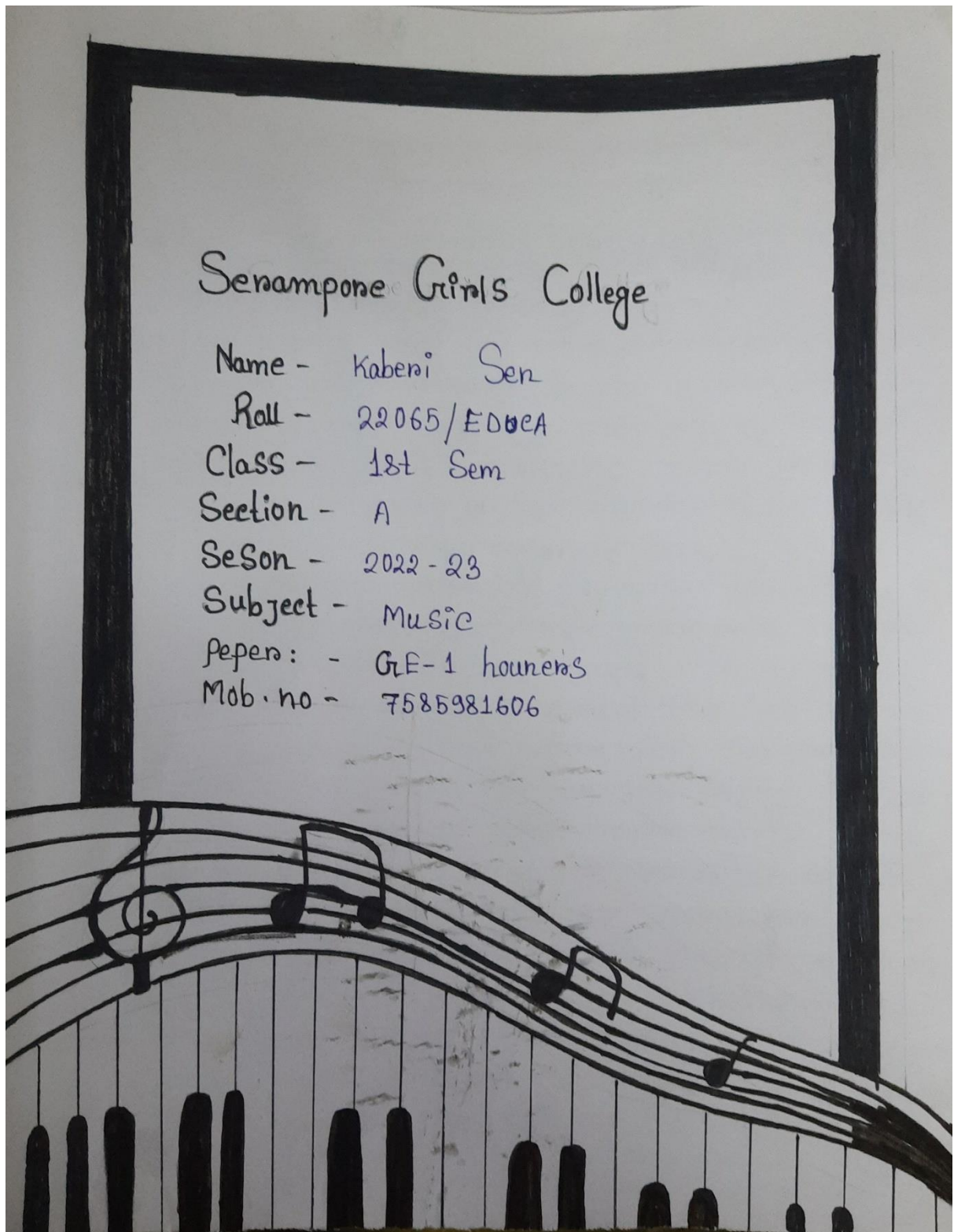

Report of Students centric method of teaching learning

Organising Department: Music Academic Session:2022-23

Report on : **Project Work**

Type of the Activity: **Experiential Learning**

Objective of the Event : Learn How to prepare a project paper

Date: 26.04.2023

Time of the Event: 9:45 am

Number of attendees: (a) 08 Student (4th semester):

(b) Teacher: 01

Venue: Department of Music (NB-06)

Supervisor: Rupa Bandyopadhyay

Outcome: They learnt a lot about how a research paper prepare by mentainprope methodology.

Attach notices, photos, attendance sheet, speakers

Notice for the students

SERAMPORE GIRLS' COLLEGE

Department of MUSIC

NOTICE

D-05.04.2023

All students of 2nd sem and 4th semester general are informed that submit your project work.

Date of submission : 25.05.2023 (2nd sem)
26.04.2023 (4th sem)

Rupa Bandgopadhyay

05.04.2023

Head of the Department
Department of Music

Report of Students centric method of teaching learning

Organising Department: Music Academic Session:2022-23

Report on Study /Educational Tour

Type of the Activity: Experiential Learning

Objective of the Event :a) To enrich students with various aspects of music like musical instruments (folk and classical) , Music Therapy etc. At the stall of Music club in academic Exhibition arranged by Serampore College

b) To make them familiar with different stall of some subjects like Geography , Botany, Education,etc.in Academic Exhibition.

Date: 24.03.2023

Time of the Event:2pm

Number of attendees (mention semester):

a) students:11 (3 students of 4thsem and 8 students of 6thsemester.)

(b) Teacher: 01

Venue:SeramporeCollege Campus,Serampore, Hooghly

Outcome:As a result, students have been interested about musical instruments and music therapy, which is a new subject to them.Some of them want to be a music therapist in future life.

Attachment :

Experiential Learning / Study Tour/Educational Tour /2022-23

NOTICE

SERAMPORE GIRLS' COLLEGE
Department of MUSIC

22.03.2023

NOTICE

Department of Music are going to arrange an educational tour for general students of 4th (B) and 6th (B) semester on 24.03.2023 for observing an 'Academic Exhibition' arranged by Serampore College, Serampore, Hooghly.

Students are requested to be present on that day for going to Serampore College Campus with permission letter for participation from their guardians in department at 2 p.m.

Rupa Bandhopadhyay
4. 0. D. 22.03.23.

IMAGES OF STUDY TOUR

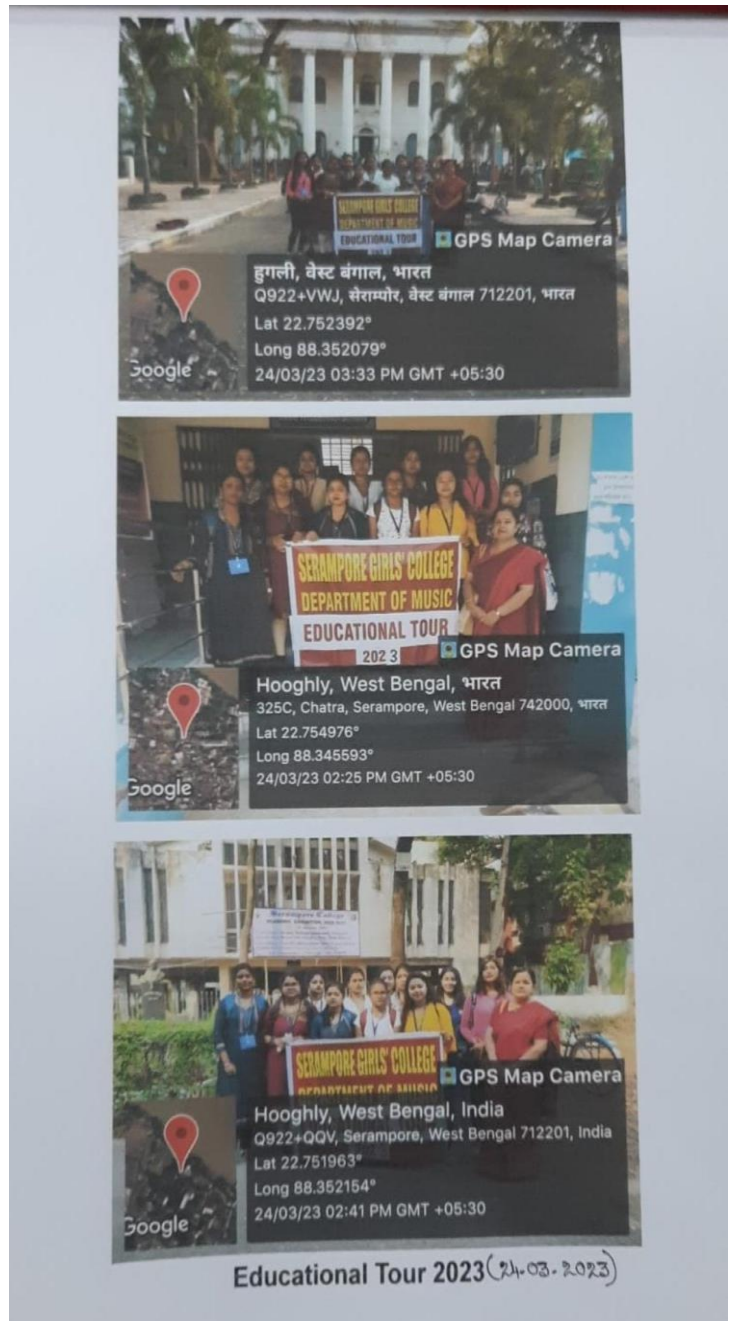

DEPARTMENT OF SOCIOLOGY

SERAMPORE GIRLS' COLLEGE

(Estd. : 1981)

Department of SOCIOLOGY

13, T. C. GOSWAMI STREET, SERAMPORE, HOOGHLY. PIN-712 201, WEST BENGAL.

Ref. No.

Report on Project / Dissertation

Date.....

Organising Department: Sociology

Academic Session: 2022 - 2023

Report on Project/Dissertation

Type of the Activity: Experiential

6th-semester Students have done Projects to meet their syllabus requirements. They have undertaken several individual topics for their projects. The topics are mainly based on various social issues, such as Child Labour, the Impact of Divorce on Children, the Socio-economic Status of Vegetable vendors etc.

Date: From 25.04.2023 to 27.05.2023

objectives of the Event

- To the fulfillment of the partial requirement of the syllabus
- To understand the sociological research methodology with their first-hand experiences.
- To know society in a better way.

Number of attendees: (a) Students: 37 (6th Semester)

(b) Teacher: Mr. Sarojit Kapasi

Outcome/Feedback

- Students could meet their syllabus requirements.
- Students could understand society and social problems in a better way.
- Students could understand various steps of the Research Methodology in a better way.

Aritra Ghosh
Head of the Department
Department of Sociology

sl	roll	name	cu roll	cu reg	marks	mobile	signature
✓ 24	20464	PRITI GANGULY	202614-12-0018	614-1211-0357-20		14	Priti Ganguly
✓ 25	20466	PRITI ROY	202614-12-0238	614-1212-0448-20		13	Priti Roy
✓ 26	20467	PRITI SANTRA	202614-12-0014	614-1211-0353-20		13	Priti Santra
✓ 27	20468	PRITIKA BARMAN	202614-12-0255	614-1212-0544-20		12	Pritika Barman
✓ 28	20470	PRIYA BAR	202614-12-0177	614-1211-0585-20		14	Priyanka Das
✓ 29	20477	PRIYANKA DAS	202614-12-0231	614-1212-0397-20		13	Purnam Shaw
✓ 30	20485	PUNAM SHAW	202614-12-0052	614-1211-0409-20			
✓ 31	20495	RIMPA KOLEY	202614-12-0109	614-1211-0490-20			
✓ 32	20499	RINKU DAS	202614-12-0044	614-1211-0398-20		14	Riya Dutta
✓ 33	20505	RIYA DUTTA	202614-12-0001	614-1211-0338-20		12	Sahana Dasgupta
✓ 34	20518	SABINA YASMIN	202614-12-0157	614-1211-0558-20		12	Sahana Parvin Das
✓ 35	20521	SAHANAZ PARVIN GAZI	202614-12-0190	614-1211-0601-20		17	Sahana Parvin Das
✓ 36	20524	SAIMA TAZEIN	202614-12-0162	614-1211-0563-20		11	Saima Khatun
✓ 37	20526	SAIMA KHATUN	202614-12-0143	614-1211-0539-20		12	Sampreeti Barik
✓ 38	20527	SAMPREETY BARIK	202614-12-0012	614-1211-0351-20		12	Sharmila Sarkar
✓ 39	20544	SHARMILA SARKAR	202614-12-0317	614-1211-0683-20		12	Shila Patra
✓ 40	20545	SHILA PATRA	202614-12-0230	614-1212-0386-20		12	Shreya Das
✓ 41	20550	SHREYA DAS	202614-12-0072	614-1211-0434-20			
✓ 42	20553	SIYA DHARA	202614-12-0029	614-1211-0379-20		14	Sohani Shaw
✓ 43	20555	SOHANI SHAW	202614-12-0073	614-1211-0364-20			
✓ 44	20556	SOLANKI DE	202614-12-0313	614-1211-0593-20		11	Sonali Shaw
✓ 45	20558	SONALI SHAW	202614-12-0059	614-1211-0417-20			
✓ 46	20559	SONI SINGH	202614-12-0113	614-1211-0494-20			
✓ 47	20563	SRABANI MALIK	202614-12-0228	614-1212-0378-20			

sl	roll	name	cu roll	cu reg	marks	mobile	signature
✓ 24	20464	PRITI GANGULY	202614-12-0018	614-1211-0357-20		14	Priti Ganguly
✓ 25	20466	PRITI ROY	202614-12-0238	614-1212-0448-20		13	Priti Roy
✓ 26	20467	PRITI SANTRA	202614-12-0014	614-1211-0353-20		13	Priti Santra
✓ 27	20468	PRITIKA BARMAN	202614-12-0255	614-1212-0544-20		12	Pritika Barman
✓ 28	20470	PRIYA BAR	202614-12-0177	614-1211-0585-20		14	Priyanka Das
✓ 29	20477	PRIYANKA DAS	202614-12-0231	614-1212-0397-20		13	Purnam Shaw
✓ 30	20485	PUNAM SHAW	202614-12-0052	614-1211-0409-20			
✓ 31	20495	RIMPA KOLEY	202614-12-0109	614-1211-0490-20			
✓ 32	20499	RINKU DAS	202614-12-0044	614-1211-0398-20		14	Riya Dutta
✓ 33	20505	RIYA DUTTA	202614-12-0001	614-1211-0338-20		12	Sahana Dasgupta
✓ 34	20518	SABINA YASMIN	202614-12-0157	614-1211-0558-20		12	Sahana Parvin Das
✓ 35	20521	SAHANAZ PARVIN GAZI	202614-12-0190	614-1211-0601-20		17	Sahana Parvin Das
✓ 36	20524	SAIMA TAZEIN	202614-12-0162	614-1211-0563-20		11	Saima Khatun
✓ 37	20526	SAIMA KHATUN	202614-12-0143	614-1211-0539-20		12	Sampreeti Barik
✓ 38	20527	SAMPREETY BARIK	202614-12-0012	614-1211-0351-20		12	Sharmila Sarkar
✓ 39	20544	SHARMILA SARKAR	202614-12-0317	614-1211-0683-20		12	Shila Patra
✓ 40	20545	SHILA PATRA	202614-12-0230	614-1212-0386-20		12	Shreya Das
✓ 41	20550	SHREYA DAS	202614-12-0072	614-1211-0434-20			
✓ 42	20553	SIYA DHARA	202614-12-0029	614-1211-0379-20		14	Sohani Shaw
✓ 43	20555	SOHANI SHAW	202614-12-0073	614-1211-0364-20			
✓ 44	20556	SOLANKI DE	202614-12-0313	614-1211-0593-20		11	Sonali Shaw
✓ 45	20558	SONALI SHAW	202614-12-0059	614-1211-0417-20			
✓ 46	20559	SONI SINGH	202614-12-0113	614-1211-0494-20			
✓ 47	20563	SRABANI MALIK	202614-12-0228	614-1212-0378-20			

• Submission Sheet of Dissertation_Sem VI

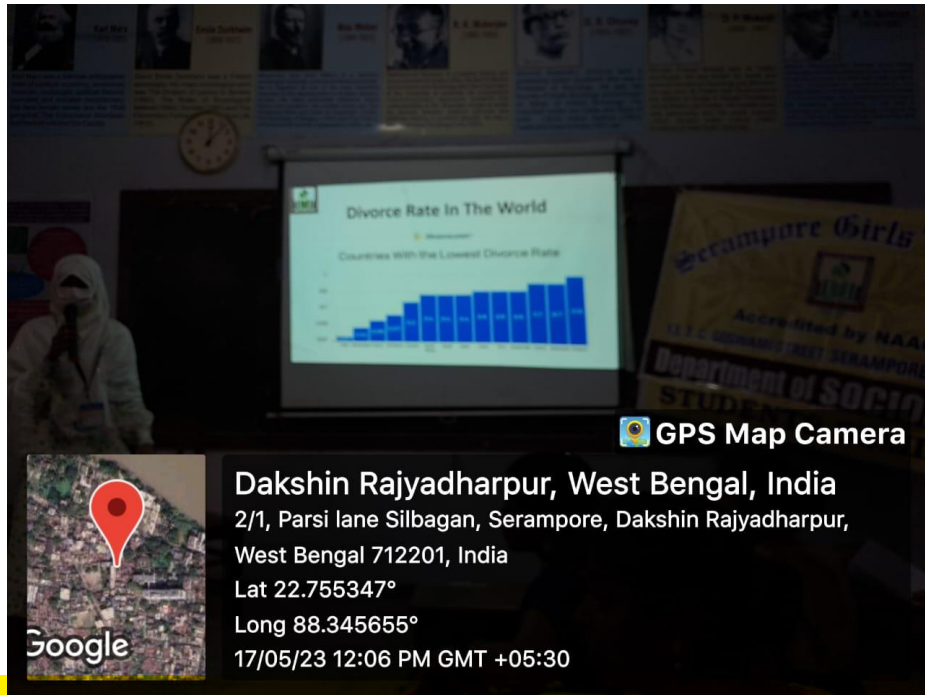

Sem VI Students' Presentation of their Dissertations on 17.05.23.

Serampore Girls' College

(Estd. : 1981)

Re-Accredited by NAAC : Grade B (2nd Cycle)

13, T. C. GOSWAMI STREET, SERAMPORE, HOOGHLY. PIN -712 201, WEST BENGAL.

E-mail : serampore_girls_college@yahoo.co.in

Website : www.seramporegirlscollege.org

Ref. No.

DEPARTMENT OF ECONOMICS

Date.....

Serampore Girls' College
(Estd.: 1981)
13, T. C. GOSWAMI STREET, SERAMPORE, HOOGHLY. PIN-712 201, WEST BENGAL.
E-mail : ecog.sgc@gmail.com
Website : www.seramporegirlscollege.org

DEPARTMENT OF ECONOMICS

Ref. No. Date

Notice for QUIZ
Session: 2022-23

Date: 4/5/2023

It is hereby informed to 2nd and 6th semester students of Economics Department, Serampore Girls college that a quiz competition will be held on following schedule. All are requested to participate in the competition and express your knowledge within your class mate and teacher.

Date for 2nd Semester: 10/5/2023, Topic: Macro Economics
Date for 6th Semester: 18/5/2023, Topic: Public Finance

Uttam Haldar
Dr. Uttam Haldar
HoD and Assistant Professor
Department of Economics,
Serampore Girls college

Dr. UTTAM HALDAR
HOD & Assistant Professor
Department & Economics
Serampore Girls' College

Soma Roy
Principal
Serampore Girls' College
Serampore, Hooghly

Serampore Girls' College

(Estd. : 1981)

Re-Accredited by NAAC : Grade B (2nd Cycle)

13, T. C. GOSWAMI STREET, SERAMPORE, HOOGHLY. PIN -712 201, WEST BENGAL.

E-mail : serampore_girls_college@yahoo.co.in

Website : www.seramporegirlscollege.org

Ref. No.

DEPARTMENT OF ECONOMICS

Date.....

 **Serampore Girls' College**
(Estd.: 1981)
13, T. C. GOSWAMI STREET, SERAMPORE, HOOGHLY. PIN-712 201, WEST BENGAL.
E-mail : ecog.sgc@gmail.com
Website : www.seramporegirlscollege.org

DEPARTMENT OF ECONOMICS

Ref. No. Date

Notice for Debate
Session: 2022-23

Date: 15/12/2022

It is hereby informed to 5th semester students of Economics Department, Serampore Girls college that a Debate competition will be held on 21/12/2022. All are requested to participate in the competition and express your knowledge within your class mate and teacher.

Uttam Halder
Dr. Uttam Halder
HoD and Assistant Professor
Department of Economics,
Serampore Girls college
Dr. UTTAM HALDAR
HOD & Assistant Professor
Department & Economics
Girls' College

Students submitting Project

Soma Roy
Principal
Serampore Girls' College
Serampore, Hooghly

Department of Geography

Departmental Educational Field Work 2023

SEMESTER: V (FIVE)

Name of Course: Report on Research Methodology and field work Lab

Code: GEO-A-CC5-11-P

Location: Mirik and Darjeeling, West Bengal

Course Objective:

Students will learn

To study the physio and socio-economic status of selected wards in Mirik Municipality

To find out the soil and water quality in the study area.

To work out the different problems related to physio and demography in the study area.

Date: 15/09/2022 to 20/9/2022

Duration: 6 days

students participated: 31

Name of Teachers:

i. Dr Asrafal Alam (Assistant Professor and HOD, Dept of Geography Serampore Girls' College),

iii. Tumpa Hudut (Teacher, Dept of Geography Serampore Girls' College)

iii. Priyanka Dey (Teacher, Dept of Geography Serampore Girls' College)

Assistant:

i. Mr. Tarun Kr. Pal (Lab Assistant, Dept of Geography Serampore Girls' College)

Course Outcome:

In this fieldwork students learned about the physio and socio-economic status of selected wards in Mirik Municipality in this field work students learned about the soil and water quality in the study area

In this fieldwork, students identified different problems from the field of physiography (undulating topography) , culture, population etc



Soma Roy
Principel
Serampore Girls' College
Serampore, Hooghly

STUDENTS (SEMESTER V HONS)

Name	CU Reg no.	CU Roll no.
Payel Pal	614-1211-0300-20	203614-11-0004
Sangita Koley	614-1211-0301-20	203614-11-0005
Soumini Dutta	614-1211-0302-20	203614-11-0006
Snehashree De	614-1211-0303-20	203614-11-0007
Doniya Pramanick	614-1211-0305-20	203614-11-0008
Soumi Dey	614-1211-0307-20	203614-11-0010
Piyali Chandra	614-1211-0313-20	203614-11-0011
Rinku Dey	614-1211-0314-20	203614-11-0012
Nibedita Das	614-1211-0316-20	203614-11-0013
Ankita Chandra	614-1211-0320-20	203614-11-0015
Dishita De	614-1211-0321-20	203614-11-0016
Suparna Adhikary	614-1211-0322-20	203614-11-0017
Priti Tatawa	614-1211-0323-20	203614-11-0018
Rupsha Dey	614-1211-0326-20	203614-11-0019
Sanjukta Sharma	614-1211-0337-20	203614-11-0025
Arpita Malik	614-1212-0295-20	203614-11-0026
Sujata Kayal	614-1212-0308-20	203614-11-0027
Pallabi Majhi	614-1212-0309	203614-11-0028
Barsha Malik	614-1212-0310-20	203614-11-0029
Sanchaita Das	614-1212-0318-20	203614-11-0030
Lisa Majumder	614-1212-0325-20	203614-11-0031
Soma Mondal	614-1212-0328-20	203614-11-0032
Priyanka Dalui	614-1212-0331-20	203614-11-0033
Sneha Tudu	614-1213-0330-20	203614-11-0034
Aiswariya Roy	614-1214-0304-20	203614-11-0035
Shreya Ghosh	614-1214-0311-20	203614-11-0036

Sreya Ash	614-1214-0324-20	203614-11-0040
Barsha Nayak	614-1214-0329-20	203614-11-0041
Saba Parween	614-1215-0294-20	203614-11-0043
Shahin Banu	614-1215-0296-20	203614-11-0044
Manisha Santra	614-1211-0679-20	203614-11-0046

Departmental Project:

Name of Course: HAZARD MANAGEMENT LAB

Code: GEO-A-CC-6-14-P

Course Objective:

1. To make use of existing knowledge in order to discover new knowledge.
2. To make sure that the learner does their own research and comes up with practical solutions to the concept they are trying to learn or the problem that they are trying to solve.
3. To study the vulnerability of different types of hazards in the real world and how to protect themselves in real-life situations.
4. To develop their time management skill.

Duration: 6 months

Students participated: 31

Topic: Flood, Earthquake,

Air pollution, Road accident, Landslides.

Name of Teachers:

i. Dr Asraful Alam (Assistant Professor and HOD, Dept of Geography, Serampore Girls' College),

Topic: Flood

iii. Tumpa Hudut (Teacher, Dept of Geography, Serampore Girls' College)

Topic: Earthquake

iii. Priyanka Dey (Teacher, Dept of Geography, Serampore Girls' College)

Topic: Air pollution.

IV. Taniya Kar (Teacher, Dept of Geography, Serampore Girls' College)

Topic: Road Accident

V. Moumita Kundu (Teacher, Dept of Geography. Serampore Girls' College)

Topic: Landslide

Assistant:

i. Mr. Tarun Kr. Pal (Lab Assistant, Dept of Geography, Serampore Girls' College)

Course Outcome:

- It gives the opportunity to test what they have learned so far in an academic session.
- it also gives the opportunity to learn
- enables the student to be more organised with his work and do things in an orderly manner.
- It also enables the student to be more organised with his work and do things in an orderly manner as a team because most projects are done in groups.
- Acquiring appropriate project writing skills gives the students a sense of independence and self-confidence which propel them to always insist on producing original research reports.
- Students are also enabled to create hazard mapping, and risk assessment which helps them to face hazards or vulnerable situations in real life.



Name of Course: Evolution of Geographical Thought Lab

Code: GEO-A-CC-6-13-P

Course Objective:

· To study how to present a topic through the poster.

· **Duration:** 6 months

students participated: 31

Topic: Radicalism., Possibilism, Behaviourism, Determinism, Humanism.

Name of Teachers:

i. Dr Asraful Alam (Assistant Professor and HOD, Dept of Geography, Serampore Girls' College), Topic: Radicalism.

iii. Tumpa Hudut (Teacher, Dept of Geography, Serampore Girls' College) Topic: Possibilism

iii. Priyanka Dey (Teacher, Dept of Geography, Serampore Girls' College) Topic: Behaviourism

IV. Taniya kar (Teacher, Dept of Geography, Serampore Girls' College) Topic: Determinism

V. Moumita Kundu (Teacher, Dept of Geography. Serampore Girls' College) Topic: Humanism

Assistant:

i. Mr. Tarun Kr. Pal (Lab Assistant, Dept of Geography, Serampore Girls' College)

STUDENTS (SEMESTER VI HONS)

Name	CU Reg no.	CU Roll no.
Payel Pal	614-1211-0300-20	203614-11-0004
Sangita Koley	614-1211-0301-20	203614-11-0005
Soumini Dutta	614-1211-0302-20	203614-11-0006
Snehashree De	614-1211-0303-20	203614-11-0007
Doniya Pramanick	614-1211-0305-20	203614-11-0008

Soumi Dey	614-1211-0307-20	203614-11-0010
Piyali Chandra	614-1211-0313-20	203614-11-0011
Rinku Dey	614-1211-0314-20	203614-11-0012
Nibedita Das	614-1211-0316-20	203614-11-0013
Ankita Chandra	614-1211-0320-20	203614-11-0015
Dishita De	614-1211-0321-20	203614-11-0016
Suparna Adhikary	614-1211-0322-20	203614-11-0017
Priti Tatawa	614-1211-0323-20	203614-11-0018
Rupsha Dey	614-1211-0326-20	203614-11-0019
Sanjukta Sharma	614-1211-0337-20	203614-11-0025
Arpita Malik	614-1212-0295-20	203614-11-0026
Sujata Kayal	614-1212-0308-20	203614-11-0027
Pallabi Majhi	614-1212-0309	203614-11-0028
Barsha Malik	614-1212-0310-20	203614-11-0029
Sanchaita Das	614-1212-0318-20	203614-11-0030
Lisa Majumder	614-1212-0325-20	203614-11-0031
Soma Mondal	614-1212-0328-20	203614-11-0032
Priyanka Dalui	614-1212-0331-20	203614-11-0033
Sneha Tudu	614-1213-0330-20	203614-11-0034
Aiswariya Roy	614-1214-0304-20	203614-11-0035
Shreya Ghosh	614-1214-0311-20	203614-11-0036
Sreya Ash	614-1214-0324-20	203614-11-0040
Barsha Nayak	614-1214-0329-20	203614-11-0041
Saba Parween	614-1215-0294-20	203614-11-0043
Shahin Banu	614-1215-0296-20	203614-11-0044
Manisha Santra	614-1211-0679-20	203614-11-0046

Course Outcome:

- In this project work students learned about the history and evolution of geography from

the Ancient to the modern era. .

- In this project work, students will enable to learn how this modern concept of geography developed and the role of contributors in this context.



EXPERIENTIAL LEARNING 2022-2023

DEPARTMENT OF BOTANY

Report on Student centric method of teaching learning

Organising Department: Botany

Academic Session: 2022-2023

Report on: Local excursion

Type of the Activity: Experiential learning.

Paper: CC1/GE1 (Plant diversity I)

Objective of the Event: Local excursion is a compulsory part of B.Sc Botany (General) degree course of semester V under CBCS curriculum. The aim is giving students a proper idea of medicinal plants, their uses and information about maintenance of the garden.

Date: 19.12.2022

Time of the Event: 12:30-01:30pm

Number of attendees: (a) Student: 5 students of semester I

(b) Teacher: Dr. Madhusree Halder

Venue: Serampore locality, Hooghly.

Outcome: Students of semester I took part enthusiastically to fulfil our goal, they gathered knowledge about different plant groups, their habit, habitat and their ecological importance. It was beneficial

Report on Student centric method of teaching learning

Organising Department: Botany

Academic Session: 2022-2023

Report on: Local excursion

Type of the Activity: Experiential learning.

Paper: CC2/GE2 (Plant diversity II)

Objective of the Event: This type of tour is organized to aware students about local plants, to know their scientific background and give them practical knowledge about collection, identification of wild angiosperms and preparation of herbarium specimens.

Date: 16.05.2023

Time of the Event: 12:30-01:30pm

Number of attendees: (a) Student: 5 students of semester II

(b) Teacher: Dr. Madhusree Halder

Venue: Chinsurah locality, Hooghly.

Outcome: Students of semester II took part enthusiastically to fulfil our goal, they learned about different groups of angiosperms, their habit, and habitat, beneficial or harmful effects on environment.

Notice

Attendance sheet

Serampore Girls' College
(Estd. 1981)
Accredited by NAAC
13, T. C. GOSWAMI STREET, SERAMPORE, HOOGHLY, PIN-712 201, WEST BENGAL.
Ph: (033) 2652 9334 • (033) 26527850 (Prin. Office) • 26623723 (Office) • 2652-0038
E-mail: science@seramporegirlscollege.org • sgccollet@sigmail.com

DEPARTMENT OF BIO-SCIENCE
Botany (General) Date: 10/05/2023



Ref. No.

NOTICE

Students of semester II, Bio science general are hereby informed that there is excursion organized from Department of Botany Serampore Girls College, at Chinsurah locality, Hooghly on 16/05/2023 All students are instructed to attend the study tour. You must carry old newspaper, rope, hard board, plastic bag, blade/scissor, note book, pen, camera, College Id card with you.

Signature of Teacher (s)
Mishra 10/5/23
Kung 10/5/23

Department of Botany
Serampore Girls' College
Serampore, Hooghly



SERAMPORE GIRLS' COLLEGE
DEPARTMENT OF BOTANY
Semester-II
Student attendance sheet

Program: Local excursion at chinsurah Date: 16/5/2023

Sl. No.	Roll Number	Sem-ster	Signature of the student
1.	22777	II	Koyal Barik
2.	22782	II	Puja Shree
3.	22790	II	Shruvi Kumari
4.	22778	II	Neha Singh

Signature of Teacher (s)
Mishra 16/5/2023
Department of Botany
Serampore Girls' College
Serampore, Hooghly



Photos of 2nd semester local excursion and collection of plants

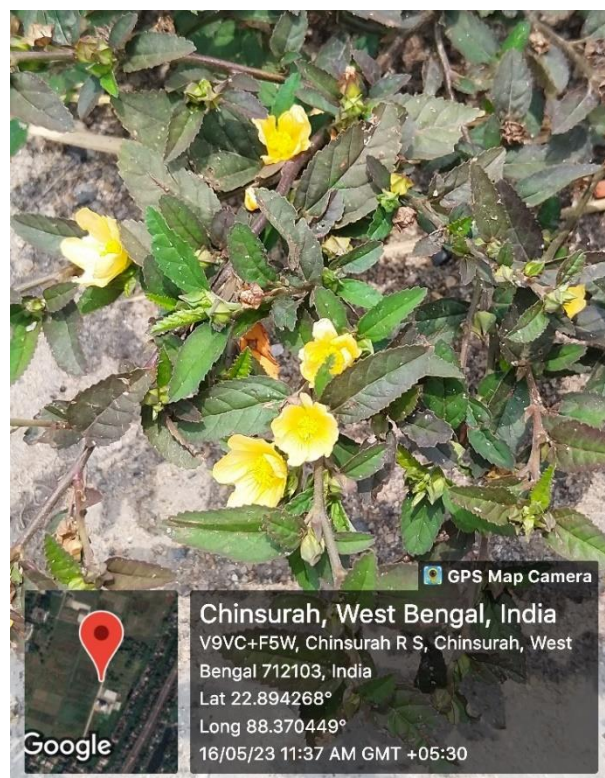

Report on Student centric method of teaching learning

Organising Department: Botany

Academic Session: 2022-2023

Report on: Medicinal garden visit

Type of the Activity: Experiential learning.

Objective of the Event: Medicinal garden visit is a compulsory part of B.Sc Botany (General) degree course of semester V under CBCS curriculum. The aim is giving students a proper idea of medicinal plants, their uses and information about maintenance of the garden.

Paper: DSE A-1 (Phyto-chemistry and medicinal Botany)

Date: 19.12.2022

Time of the Event: 11:00-12:30pm

Number of attendees: (a) Student: 6 students of semester V

(b) Teacher: Dr. Madhusree Halder

Venue: Serampore College Medicinal garden, Hooghly.

Speaker: Dr. Suman Datta. Assistant Professor, Department of Botany, Serampore College.

Outcome: Students of semester V took part enthusiastically to fulfil our goal, they experienced different practical facts regarding methods of use of medicinal plants and specifically parts of plants used for different diseases.

REPORT ON STUDENT CENTRIC TEACHING LEARNING

Organising Department: Botany

Academic Session: 2022-2023

Report on: Field Visit

Type of the Activity: Experiential learning

Objective of the Event: Field visit is a compulsory part of B.Sc Botany (General) degree course of semester VI under CBCS curriculum. Objective of this type of tour is to aware students about the cultivation method, timing and every minute details of the cultivated plants and its importance to our society.

Paper: DSE-B1 (Economic Botany)

Date: 16.05.2023

Time of the Event: 11-12:30pm

Number of attendees: (a) Student: 5 students of semester VI

(b) Teacher: Dr. Madhusree Halder

Venue: Chinsurah Rice Research Station, Chinsurah. Hooghly

Outcome: Students of semester VI took part enthusiastically to fulfil our goal, they experienced different practical facts about our staple food crop and its socio-economic value.

Notice

Attendance sheet

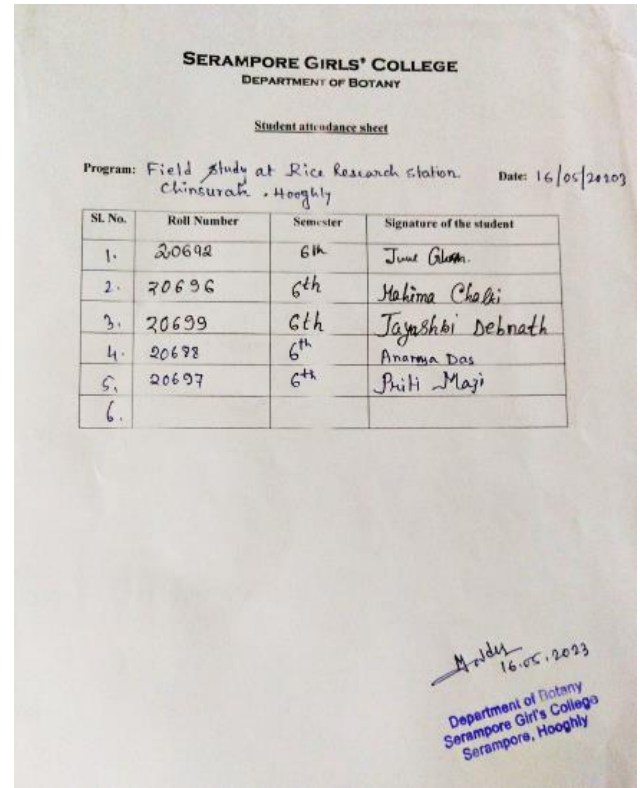
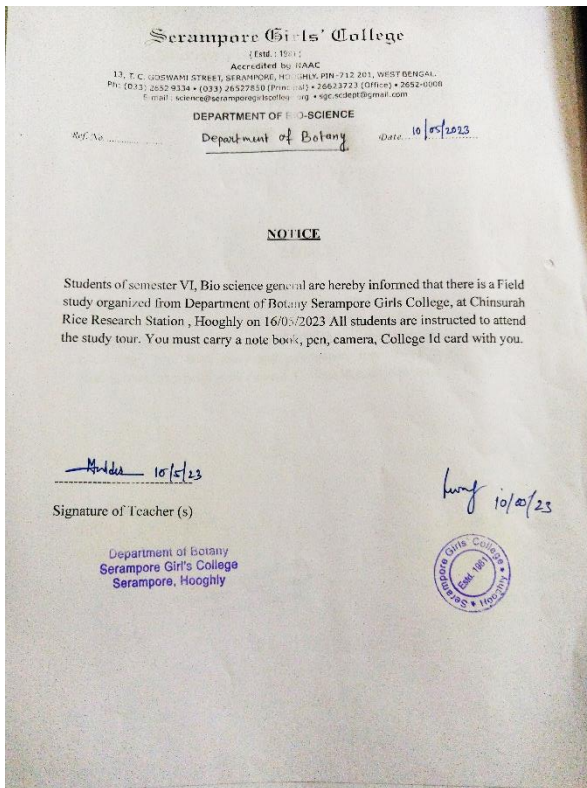

Photos of field study at Rice research station, Chinsurah, Hooghly (students of 6th semester with female farmers)

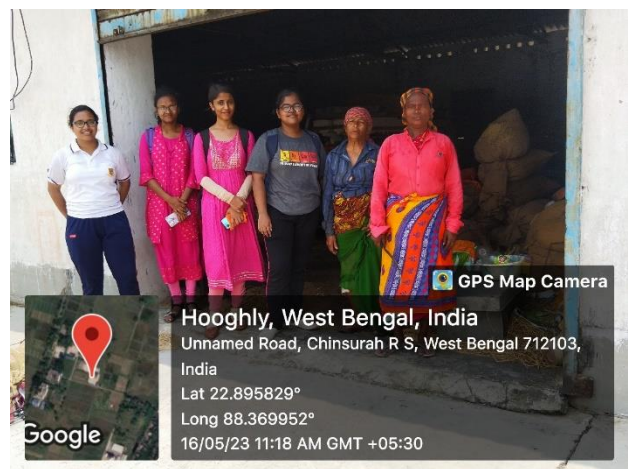
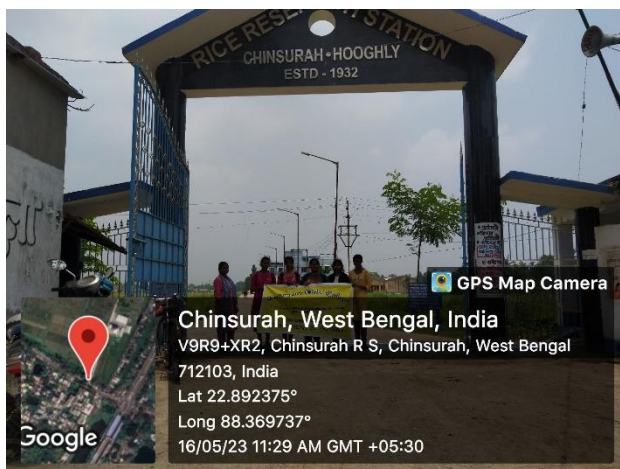

PROJECT WORK REPORT 2022-2023

REPORT ON PROJECT WORK OF CC13 and CC14 (COMPUTER SCIENCE)

Academic Session: 2022-2023

SEMSTER: VI (HONOURS)

Name of Course: PROJECT WORK

Code: CC13 & CC14

Location: Serampore Girls' College, WEST BENGAL

Course Objective:

Students will learn about software or website making steps.. Also know about the software maintenance.

Date of report submission: yet not submitted (exam will be conducted on 3rd August,2023.

Duration: 6 months (1 semester)

students enrolled: 8

Student submitted:.8

Guided by:

Moumita Ghosal (Department of Computer Science, Serampore Girls' College)

Course Outcome:

- Students were able to learn basic software making details and presentation.

SYLLABUS OF THE COURSE

- N Chandrasekharan, 3rd Edition, PHI.
 3. Introduction to Theory of Computation by Micheal Sipser, 3rd Edition, Cengage Learning.
 4. Switching and Finite Automata Theory by Zvi Kohavi, Niraj K. Jha, 3rd Edition, TMH.
 5. Formal Language and Automata, P. Linz, Narosa

CMS-A-CC-6-14-P: Project Work

Core Course-14, Practical, Credit:04, Contact hours: 60.

Candidates have to do their project in any relevant topic, under the supervision of teachers.

Discipline Specific Elective Course A: DSE-A

CMS-A-DSE-A-3-TH: Embedded Systems

DSE-A: Choice-3: Theory, Credit:04, Contact hours: 60.

Introduction to 8051 Overview of Microcontroller, Memory, I/O interface Intel Microcontroller 8051: Architecture, Peripheral Interface Controller (PIC).	15 hours
Assembly Language Programming Instruction set, Addressing Modes, Jump, Loop and Call instructions, I/O Manipulation, Serial communication, Arithmetic and logical instructions.	10 hours
Introduction to Embedded System Programming Data types and time delays, I/O programming, Logic operations, Data conversions, Data serialization, Interrupt programming, LCD and Keyboard interfacing, ADC, DAC, sensors interfacing, interfacing 8255, I/O interfacing for 8051, interfacing 8255, 8257, 8259/ 8279, ADC, DAC, Motor control using 8051 C.	15 hours
Programmable logic devices and Hardware description Language PAL, PLA, PLD, ASIC, FPGA (Qualitative study).	10 hours
Hardware Description Language (VHDL): Basic Terminology, Entity Declaration, Architecture body, Configuration and package declaration, Package body, Model analysis and Simulation. Basic Language elements, Behavioral Model, Dataflow Model, Structural Model, Subprogram and overloading, Applications.	15 hours

CMS-A-DSE-A-3-P: Embedded Systems Lab.

DSE-A: Choice-3, Practical, Credit: 02, Contact hours: 40 hours

Practical: Sample practical problems can be included related to theory.

1. Assembly Language Programming related to Microcontroller 8051.
2. Programming Using Embedded C for 8051.
3. VHDL programs for construction and simulation of various digital circuits.

NOTICE FOR THE PROJECT

nm

Serampore Girls' College

(Est. : 1981)

Accredited by NAAC

13, T. C. GOSWAMI STREET, SERAMPORE, HOOGHLY, PIN-712 201, WEST BENGAL.
Ph: (033) 2652 9334 • (033) 2652788 (Principal) • 26623723 (Office) • 2652-0008
E-mail : science@seramporegirlscollege.org • sgc.scdept@gmail.com

Department of SCIENCE

Ref. No.

Date. 01.04.2023

NOTICE

on

Project Work Distribution

Students of Semester 6 of Computer Science Honours are here by notified that their Project work (Paper CC13 & CC14 Practical) will be done as per following topics.

Group	Name of the students	Project Title	Guide
Group 1	Sohinee Sengupta Soma Das	App Generation	Sri Debkanti Das
Group 2	Prakriti Banerjee Punam Kumari	Student Course Management System	Sri Anjan Goswami
Group 3	Ekta Prasad Swati Paswan	Hotel Reservation System	Ms. Moumita Ghosal
Group 4	Sathi Som Elisha Mitra	Student Progression Management System	Ms. Moumita Ghosal

Moumita Ghosal



Department of Computer Science
Serampore Girls' College

Dept. of Computer Science
Serampore Girls' College
Serampore, Hooghly, W.B.
Pin - 712 201

Soma Roy
Principal
Serampore Girls' College
Serampore, Hooghly

SERAMPORE GIRLS' COLLEGE

(ESTD.:1981)



CERTIFICATE

This is to certify that Soma Das student of
B.Sc Sem VI Computer Science Honours of Serampore
Girls' College, Roll No. 203614-11-0021 has
completed her project titled

Cake & Snacks shop management system

under the guidance of Ms. Moumita Ghosal.

Moumita Ghosal

1.8.23

Signature of the guide



Moumita Ghosal

Signature of Head of the
Department

Soma Roy
Principal
Serampore Girls' College
Serampore, Hooghly

Serampore Girls' College

(Estd: 1981)

Accredited by NAAC

13, T.C. GOSWAMI STREET, SERAMPORE, HOOGHLY, PIN-712201, WEST BENGAL.

Ph: (033) 26529334 • (033) 26527850 (Principal) • 26623723 (Office) • 2652-0008

E-mail : science@seramporegirlscollege.org • sgc.scdept@gmail.com

Department of Science

Ref No: _____

Date: 1.8.23

PROJECT COMPLETION CERTIFICATE

To Whom It May Concern

This is to certify that Elisha Mitra
student of B.Sc. Sem VI Computer Science Honours of
Serampore Girls' College, Roll No. 203614-11-0009
has completed her project titled Student Progression
Management System
under the guidance of Ms. Moumita Ghosal.

Moumita Ghosal.

1.8.23

Signature of the guide
Serampore Girls' College



Moumita Ghosal

Signature of Head of the
Departmental
Serampore Girls' College

Head of the Department
Department of Computer Science

AWARD LIST OF UNIVERSITY OF CALCUTTA



UNIVERSITY OF CALCUTTA

Award List (Practical Examination)
B.A./B.Sc. SEMESTER - VI (Honours) Examination (Under CBCS), 2023

College/Centre : SERAMPORE GIRLS COLLEGE (614)

Subject : CMSA

Course : CC13

Subject Category : HONOURS

Assessment Type : Practical

Course Name : SOFTWARE ENGINEERING AND PROJECT DESIGN & DOCUMENTATION

Foil No. : 5999

Batch No. : 1

Srl No.	Roll Numbers	Registration Numbers	Signature of Candidates	[FM 30]		
				Marks Obtained		
				Examiner	Scrutineer	HE
1	203614-11-0001	614-1211-0297-20	Sohinee Sengupta	27		
2	203614-11-0009	614-1211-0306-20	Elisha Mitra	28		
3	203614-11-0014	614-1211-0317-20	Swati Paswan	24		
4	203614-11-0020	614-1211-0327-20	Prakruti Banerjee	28		
5	203614-11-0021	614-1211-0332-20	Soma Das	27		
6	203614-11-0038	614-1214-0315-20	Ekta Prasad	24		
7	203614-11-0039	614-1214-0319-20	Sathi Som	28		
8	203614-11-0045	611-1211-0497-17	Punam Kumari	28		

unacademy (Internal)
Arijit Kameng

Moumita Ghosal (Internal)
3.8.23
Arijit Kameng 03/08/23

Signature of Internal/External Examiner(s)

Signature of Scrutineer(s)

Signature of HE with date & seal

Soma Roy
Principal
Serampore Girls' College
Serampore, Hooghly

STUDENTS DURING FINAL PROJECT PRESENTATION

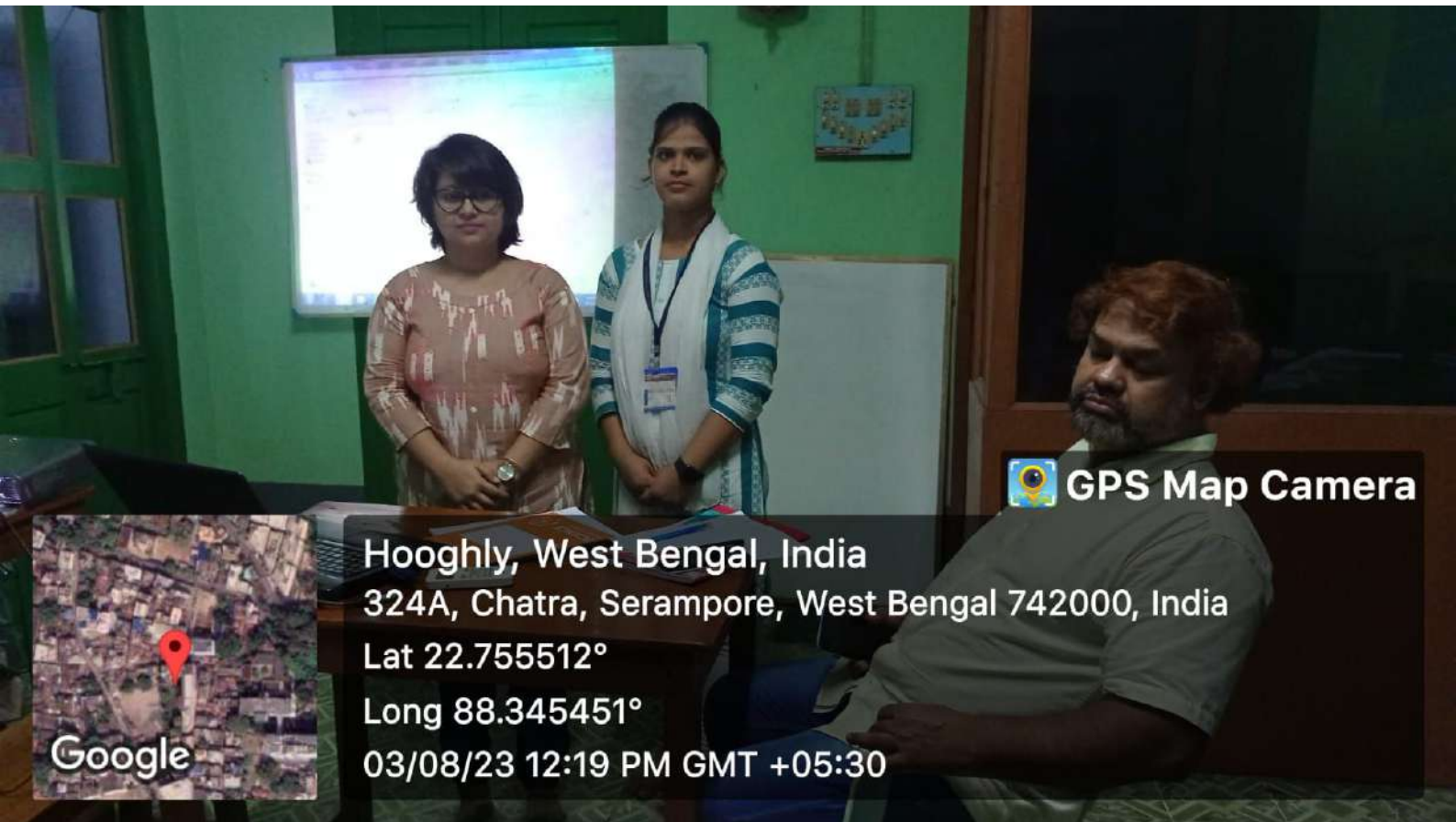

STUDENTS DURING FINAL PROJECT PRESENTATION

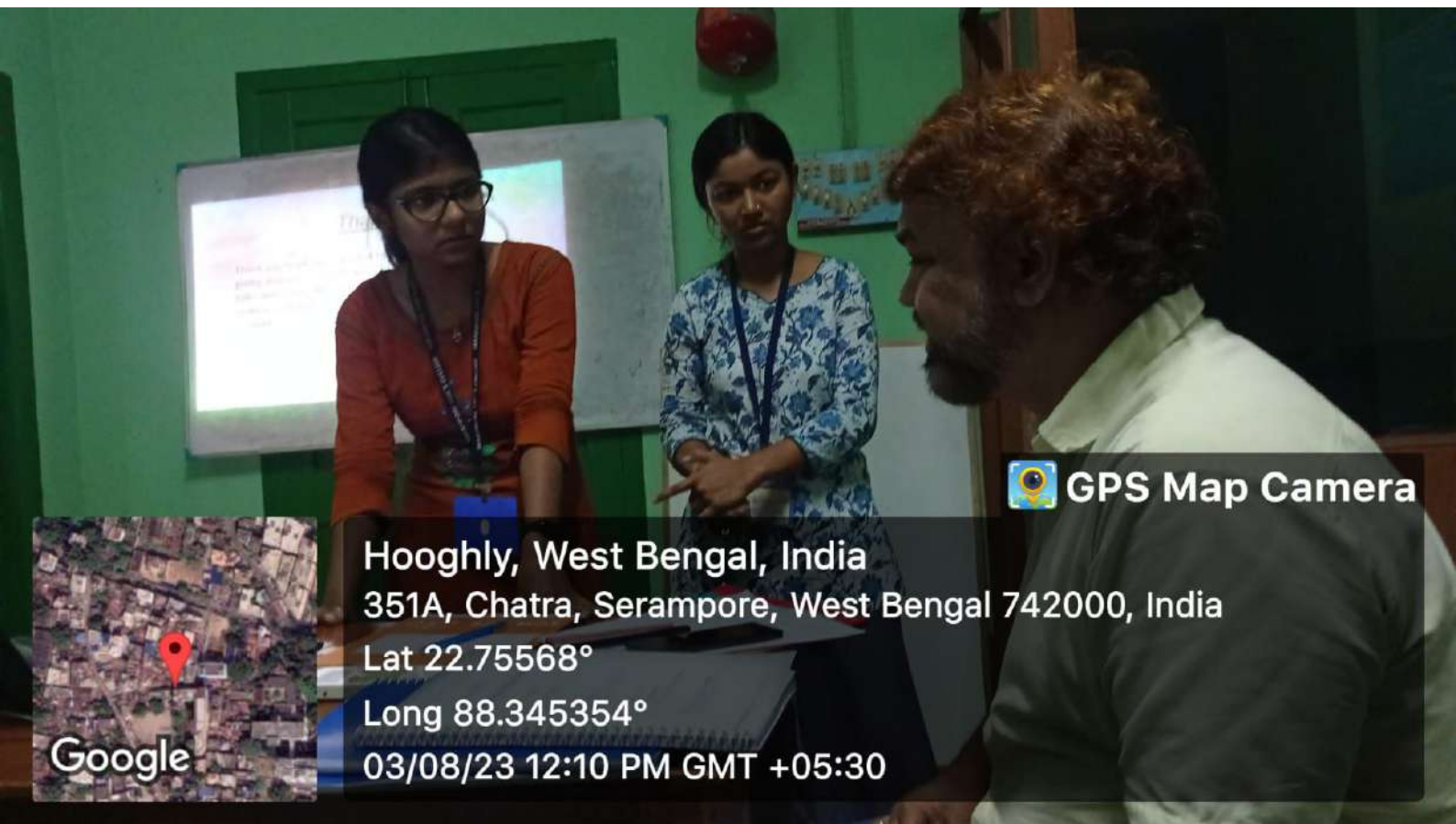

GPS Map Camera
Hooghly, West Bengal, India
351A, Chatra, Serampore, West Bengal 742000, India
Lat 22.75568°
Long 88.345354°
03/08/23 12:10 PM GMT +05:30

UNIVERSITY OF CALCUTTA

B.Sc. SEMESTER-VI (HONOURS) Examination-2023

(UNDER CBCS)

Subject-CMSA CC-13(P)

Project Report

Student Course Management System

Presented By-

Prakriti Banerjee

Punam Kumari

Supervised By:-

Mr Anjan Goswami

Project Report

Cake & Snacks Shop management System

Submitted by

Sohinee Sengupta

Roll Number: 203614-11-0001

Registration Number: 614-1211-0297-20

&

Soma Das

Roll Number: 203614-11-0021

Registration Number: 614-1211-0332-20

Supervised by

Ms. Moumita Ghosal

Assistant Professor,

Department of Computer Science, Serampore Girls' College

Dept. Of Computer Science
UNIVERSITY OF CALCUTTA

DEPARTMENT OF EDUCATION

Report format of Students centric method of teaching learning

Organising Department: EDUCATION

Academic Session:2022-2023

Report on

Study Tour

Type of the Activity: Experiential

Objective of the Event: To make students aware about the role of Serampore in spreading education and culture

Date: 12.04.2023

Time of the Event:2:00 pm

Number of attendees: (a) Student (mention semester): Semester-4 (07 students), Semester-6 (14 Students)

(b) Teacher: 04

Venue: MUSEUM AT GOVERNER'S HOUSE, SERAMPORE

Speakers (if any): Mr MOHIT RANADEEP, MEMBER OF SERAMPORE HERITAGE RESTORATION INITIATIVE (SHRI)

Outcome: Students became aware about the role of Serampore in spreading education and culture.

Attachments:

Serampore Girls' College

(Estd. : 1981)

13, T. C. GOSWAMI STREET, SERAMPORE, HOOGHLY, PIN-712 201, W.B. ̈ 2662 3723

Department of EDUCATION

Ref. No.

Date... 05/04/2023

NOTICE

This is to certify all the students of Semester-IV & VI (Honours) that a Study Tour will be held on 12.04.2023. All the students are hereby informed that they should come to the department for the said tour positively.

S. K. Bhosme
Head of the Department
Department of Education

NOTICE FOR STUDENTS



EVENT: STUDY TOUR

DATE: 12.04.2023

SEMESTER: 4&6

SERAMPORE GIRLS' COLLEGE

DEPARTMENT OF ~~ENGLISH~~ EDUCATION

SEMINAR/ EXTENSION LECTURE/ OPEN HOUSE/

QUIZ /EDUCATIONAL TOUR/ OTHERS

TIME: 2:00pm -

DATE: 12/04/2023

S.N	NAME OF THE PARTICIPANTS	COLLEGE ROLL NO.	SEMESTER
1.	Adrita Debbaraya	20057	6th SEM
2.	Lakshmi Das	20043	6th SEM
3.	Garvit Saha	20067	6th SEM
4.	Prati Koley	20085	6th sem
5.	Bishakha Ghosh	20063	6th sem
6.	Saha Karmakore	20069	6th Sem
7.	Anamika Koley	20050	6th Sem
8.	Prayanta Paul	20087	6th sem
9.	Anshi Dule	20084	6th sem
10.	Suvarida Das	20104	6th SEM
11.	Kallabi Das	20081	6th sem
12.	Kaya Koley	20071	6th sem
13.	Mou Saha	20078	6th Sem
14.	Riya pramanik	20090	6th Sem

J. K. Ghose
SIGNATURE OF H.O.D

Head of the Department
Department of Education

Soma Roy, 12/4/23.
SIGNATURE OF PRINCIPAL

Principal
Serampore Girls' College
Serampore, Hooghly

SAMPLE ATTENDANCE OF STUDENTS

Soma Roy
Principal
Serampore Girls' College
Serampore, Hooghly



PROJECT WORK REPORT 2022-2023

REPORT ON PROJECT WORK OF Arduino SEC B -1 (PHYSICS)

Academic Session: 2022-2023

SEMSTER: IV (GEN)

Name of Course: ARDUINO (PROJECT TYPE)

Code: SEC B1

Location: Serampore Girls' College, WEST BENGAL

Course Objective:

Students will learn

- 1. LED Blinking and fading. 2. Measurement of voltages (Below 5 V and above). 3. Interfacing 7 Segment display. 4. Construction of thermometer using LM35 or Others

Date of report submission: 25/06/2023 to 27/06/2023

Duration: 6 months (1 semester)

students enrolled: 4

Student submitted: 4

Guided by:

Dr. Sandip Majumdar (Department of Physics, Serampore Girls' College)

Course Outcome:

- Students were able to learn basic projects using Arduino Uno kit.

SEC B -1 (Technical Skill)

4.2 Arduino (Project type)

4.2.1 Arduino

Paper PHS-A-SEC-B-TH	Credit 1
-----------------------------	-----------------

1. Introduction to Arduino

2 Lectures

Brief history of the Arduino; open-source electronics prototyping.

2. Basic ideas

3 Lectures

Basic ideas of Arduino, Familiarize the Arduino board, Setting up the arduino board. Installation of IDE in PC/ laptop for Arduino programming(Sketch)

3. Arduino Programming:

10 Lectures

(a) Program structure:

data types, variables and constants, operators, control statements, loops, functions, string.

(b) Interfacing:

serial communication, digital and analog input/output, getting input from sensors(e.g. temperature sensor, ultrasonic sensor etc)

Books and references

1. Arduino Cookbook, Michael Margolis, O'Reilly Media (2011)
2. Getting Started with Arduino, Massimo Banzi, O'Reilly Media(2009)
3. Arduino as a tool for physics experiments, Giovanni Organtini 2018 J. Phys.: Conf. Ser. 1076 012026
4. <https://www.arduino.cc/en/Guide/HomePage>
5. Physics Today 66, 11, 8 (2013); <https://doi.org/10.1063/PT.3.2160>
6. The Physics Teacher 52, 157 (2014); <https://doi.org/10.1119/1.4865518>

4.2.2 Practical Projects

Paper PHS-A-SEC-B-PR	Credit 1
-----------------------------	-----------------

1. LED Blinking and fading.
2. Measurement of voltages (Below 5 V and above).
3. Interfacing 7 Segment display.
4. Construction of thermometer using LM35 or Others.

5. Construct the experimental set up for studying simple pendulum and hence determine the acceleration's due to gravity.

6. Construct data logger for studying charging and discharging of RC circuit.

NOTE: Software required: Arduino Integrated Development Environment, Hardware required: Arduino Uno

SEC B -2 (Knowledge Skill)

4.3 Electrical Circuits and Network skills (Theory)

PHS-A SEC-B -TH

Credit 2

1. DC generator :

10 Lectures

(a) EMF generated in the armature for simplex lap and wave winding, concept of pole, Methods of Excitation, Armature reaction, Dc motor : Torque equation of D.C motor, speed & torque Operating Characteristics of separately excited, Shunt, Series & Compound motors with emphasis on application areas.

(b) Three phase generator, concept of stator and rotor, star and delta connections – their current voltage relationships (both line and phase current & voltage).

2. Transformer :

5 Lectures

Types of transformer, basic emf equation, no load current, leakage inductance, Magnetising current and equivalent circuit of single phase transformer on no-load and on load, idea of star/star, star/delta, delta/star, and zig-zag connection of 3 phase transformer, 3 phase to 2 phase transformation, Scott T connection.

3. AC motor

6 Lectures

(a) Single phase AC motor – double field revolving theory, slip-speed characteristics,

(b) Construction of 3 phase induction motor and its action using rotating field theory, equivalent circuit of induction motor, Speed control by V/f control of induction motor (block diagram only).

4. Measurements and faults

9 Lectures

(a) Measurement of three phase power by two and three wattmeter method, theory of induction type wattmeter and its use as energy meter in domestic house. Megger.

(b) Unsymmetrical faults in distribution system, Common switchgear equipments like relay, circuit breakers and fuses, Simple oil circuit breaker and SF6 circuit breaker, Construction of protective relay in distribution bus-bar system, Block diagram of a utility distribution sub-station.

Reference Books

1. Text book on Electrical Technology (vol 1 & 2), Thereja and Thereja
2. Power System, V. K. Meheta
3. Electrical Machines, S. K. Bhattacharya

Serampore Girls' College

13, T.C. Goswami Street Serampore Hooghly - 712201 West Bengal

NAAC Criteria 1.3.1



NOTICE FOR PROJECT ASSIGNMENTS

NOTICE FOR PROJECT PRACTICAL ASSIGNMENT

SEM IV Paper: Arduino

Code: SEC-B1

Subject : Physics

SI	Name	Roll	Name of the Project
1	Asiya Parvin	21344	LED Blinking and fading.
2	Moshahida	21351	Measurement of voltages (Below 5 V and above).
3	Shana Shahid	21366	Interfacing 7 Segment display
4	Nishu Bhagat	21355	Construction of thermometer using LM35 or Others

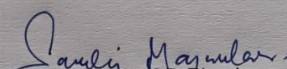
Signature of HOD Physics

College/Centre : SERAMPORE GIRLS COLLEGE (614)

Subject : PHSG

Course : SEC-B1

Subject Category : GENERAL

Assessment Type : Practical

Course Name : ARDRUINO

Foil No. : 1886

Srl No.	Roll Numbers	Registration Numbers	Signature of Candidates	[FM 60]	
				Marks Obtained	
				Examiner	Scrutineer
1	213614-12-0004	614-1211-0726-21	Nishu Bhagat		
2	213614-12-0015	614-1211-0739-21	Moshakida Tabassum		
3	213614-12-0036	614-1215-0747-21	Asiya Farvin		
4	213614-12-0037	614-1215-0749-21	Shana Sahid		

ATTENDANCE OF STUDENTS

Soma Roy
Principal
Serampore Girls' College
Serampore, Hooghly

Signature of Internal Examiner(s)

Signature of Scrutineer(s)

Signature of Principal/TIC/OIC/HE with date & seal

PROJECT REPORT ON

ARDUINO

Subject: Physics
Paper: SEC
Paper code: B1

Presented by:

NISHU BHAGAT
CU Roll: 213614-12-0004
Registration no:- 614-1211-0726-21
College roll no;- 21355
Semester: 4TH

Serampore Girls College
13, T.C. Goswami Street Serampore Hooghly - 712201 West Bengal



Soma Roy
Principal
Serampore Girls' College
Serampore, Hooghly

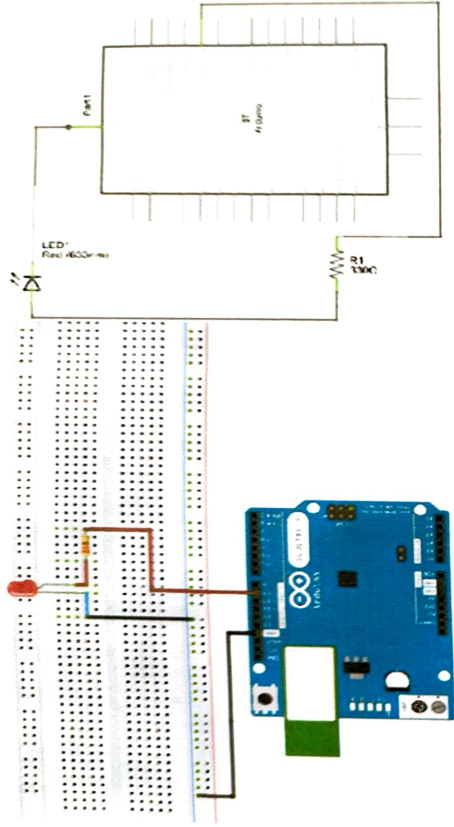

NOTE - To find out the polarity of an LED, look at it closely. The shorter of the two legs, towards the flat edge of the bulb indicates the negative terminal.

Components like resistors need to have their terminals bent into 90° angles in order to fit the breadboard sockets properly. We can also cut the terminals shorter.

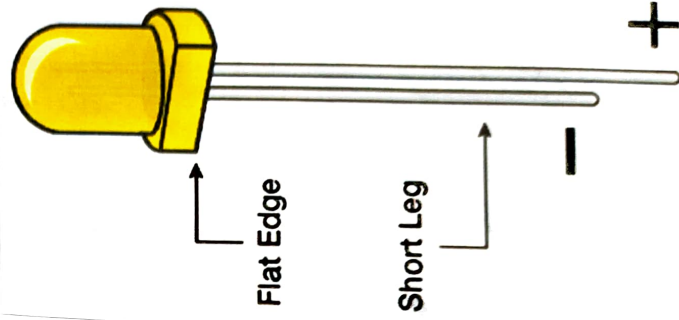
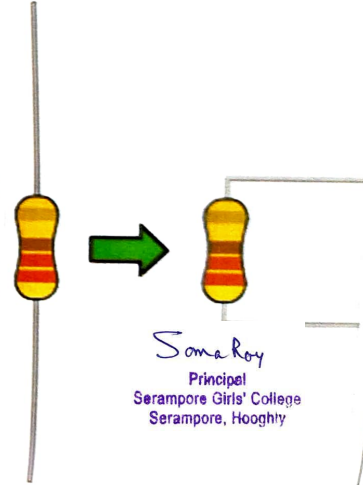

Soma Roy
Principal
Serampore Girls' College
Serampore, Hooghly

PROJECT REPORT ON

LED Blinking and fading

Subject : Physics

Paper : Arduino

Paper : **PHSG**

Presented by,

ASIYA PARVIN

CU Roll No. : 213614-12-0036

Registration No. : 614-1215-0747-21

College Roll No. : 2130144

Semester : 4th

Serampore Girls College

13, T.C. Gosawami Street Serampore Hooghly- 712201, West Bengal

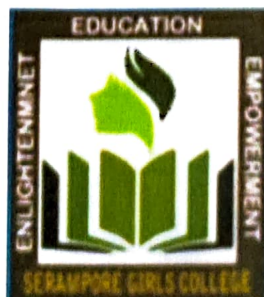

DEPARTMENT OF ZOOLOGY

Report on Student centric method of teaching learning

Organising Department: Zoology

Academic Session: 2022-23

Report on Visit to Natural History Museum

Type of the Activity: Experiential learning

Objective of the Event To help students gaining more practical knowledge of evolution

Date: 15th June, 2023

Time of the Event: 10:00 am – 3:00 pm

Number of attendees: (a) Student (mention semester): 9 STUDENTS OF 4TH SEMESTER

(b) Teacher: Dr. Ananya Ali

Venue: The Indian Museum, Kolkata

Outcome: Enhanced knowledge of students about natural variation and diversity, presents at biological world and systems.

Serampore Girls' College

(Estd. : 1981)
 Accredited by NAAC
 13, T. C. GOSWAMI STREET, SERAPORE, HOOGHLY, PIN-712 201, WEST BENGAL.
 Ph: (033) 2652-9334 • (033) 2652781 • (Principal) • 26623723 (Office) • 2652-0008
 E-mail : science@seramporegirlscollege.org • sgc.scdept@gmail.com

Departments of Biological Sciences

Ref. No. _____ Dept. of Zoology Date: 12/06/2023

NOTICE

All the students of fourth (4th) semester semester are hereby being notified that a/an field visit to a museum program has been arranged by Zoology department(s) on 15/06/2023 (Three day).

Thus, all are being requested to be present on that day and take part enthusiastically to above mentioned program.

N.B.: All are being requested to submit 150/-, along with their name to Dr. Mushmura Halder, before the tour date for same.

Ananyadi Halder
 Department of Zoology
 Serampore Girls' College
 Serampore, Hooghly

NOTICE

Serampore Girls' College

Department(s) of Zoology
 Attendance sheet

Program: Visit to a natural history Museum Date: 15/06/2023

Sl No.	Name	College Roll No.	Paid	Sign	Cont. No.		
1	Lipika Saha	21349	150/-	Lipika Saha	999618632		
2	Sania Qamar	21368	150/-	Sania Qamar	6290149320		
3	Mouli Kaly	21352	150/-	Mouli Kaly	3748893670		
4	Saheli Tudu	21363	150/-	Saheli Tudu	8609046121		
5	Sudhama Das	21370	150/-	Sudhama Das	9193354114		
6	Sonal Singh	21367	150/-	Sonal Singh	0291651201		
7	Pallavi Tiwari	21356	150/-	Pallavi Tiwari	725019092		
8	Raktambika Ghosh	21361	150/-	Raktambika Ghosh	8291058579		
9	Suhita Bhattacharya	21371	150/-	Suhita Bhattacharya	8585068074		
10							

Ananyadi Halder
 Department of Zoology
 Serampore Girls' College
 Serampore, Hooghly

ATTENDANCE



Students in front of The Indian Museum, Kolkata



Students inside The Indian Museum, Kolkata